

BLACK 黑

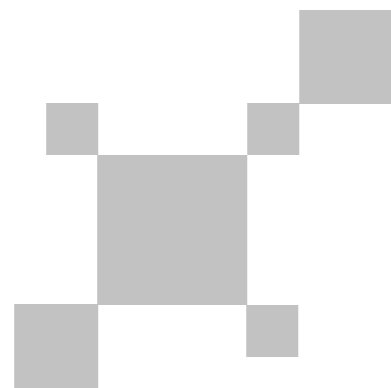

UNI-T®



UTD2000L

OPERATING
MANUAL

Digital Storage
Oscilloscope

Introduction

Dear valued customer,

Thank you for purchasing a Uni-Trend instrument. To use your new product correctly, make sure you read this User Manual carefully and completely before operation and pay particular attention to the “Safety Instructions” section .

Please keep this User Manual in a safe place after reading it carefully. For easy reference during future operation, we recommend putting it alongside your Uni-Trend product or in an easily accessible place.

Copyright Information

- **UNI-T** Uni-Trend Technology (Dongguan) Ltd. All rights reserved.
products are protected by patents granted and pending in the People 's Republic of China and other countries .
- **UNI-T** The Company reserves the right to change product specifications and prices.
- **UNI-T** all rights reserved. All licensed software products are properties of Uni-T and its subsidiaries or suppliers . They are protected by the national copyright law and international conventions. Information contained in this manual supercedes all information in previously published versions.

UNI-T is the registered trademark of Uni-Trend Technology (Dongguan) Ltd.

If this product is sold or assigned by the original purchaser to a third party within three years of purchase, the new owner should note that warranty is available for a period of three years from the day the original purchaser acquired the product from Uni-T or an authorized dealer. The probe, other accessories and fuses are not covered by warranty.

If any genuine defect is found during the valid warranty period, Uni-T has the option to repair the defective product without any charge for parts or labor, or replace it with another product (at the discretion of Uni-T). Uni-T may use parts, modules and replacement products that are brand new or repaired to a good-as-new standard. All old parts, modules and products that are removed during replacement become properties of Uni-T.

In this User Manual, “customer” means an individual or entity vested with the rights hereunder. To enjoy the warranty service, the “customer” must report any defect to Uni-T during the valid warranty period and make appropriate arrangement to allow servicing. The customer should pack the defective product in a container and deliver it to a maintenance centre specified by Uni-T. The customer should also prepay all freight cost and provide a copy of the

original sales receipt issued to the original purchaser. If the product is to be delivered to an address within the country where the maintenance centre operates, Uni-T shall pay the cost of returning the product to the destination, all freight, custom duty, tax and other costs will be paid by the customer.

This warranty does not apply to any defect, malfunction or damage caused by accident, normal wear and tear of mechanical parts, any form of application other than the stated ones, improper use, improper maintenance or poor maintenance. Under the warranty terms and conditions, Uni-T has no obligation to provide the following services :

- a) Repairing any damage arising from installation, repair or maintenance carried out by a non Uni-T service representative ;
- b) Repairing any damage arising from improper use or connection to incompatible equipment ;
- c) Repairing any damage or malfunction arising from using a power source not provided by Uni-T ;
- d) Servicing a product that has been modified or integrated with other products (such modification or integration makes repair more time consuming and difficult) .

UTD2000L User Manual

This warranty is made available to this product specifically and supercedes all other previous warranties, whether express or implied. Uni-T and its dealers will not make any implied guarantee on the salability or suitability of this product for any specific purpose. In the event of breach of warranty terms and conditions, repair or replacement of defective product shall be the only and all remedial measure offered by Uni-T. Notwithstanding any prior notification of potential damage that is indirect, special, consequential or inevitable, Uni-T and its dealers shall bear no liability for any such damage.

Safety Instructions

This unit is designed and manufactured strictly in accordance with GB4793 safety requirements for electronic testing meters and IEC61010-1 safety standards. It fully meets CAT II 600V insulation and overvoltage requirements and Grade II anti-pollution safety standards. To prevent personal injuries and damage of this unit or any other devices connected to it, please take note of the following safety precautions. To avoid potential hazards, use this unit strictly as instructed by this User Manual.

Maintenance should only be carried out by a trained professional.

To avoid fire and personal injury :

Use a correct power cable : Use only the specified power cable which is authorized in the country of use.

Remove the plug correctly : Do not remove the probe or testing cable when they are connected to power.

Ensure good grounding : This unit is grounded by the ground wire of the power cable. To avoid electric shock, the grounding conductor must touch the ground. Before connecting the input or output terminal, ensure the unit is properly grounded.

Connect the probe of the digital storage oscilloscope : The probe ground cable is the same as ground potential. Do not connect the ground cable to non ground voltage or high voltage.

Check the rated values of all terminals : To prevent fire and excessive current shock, please check all rated values and label data. Read the manual carefully and check the rated values before connecting the unit.

Do not operate the unit with the chassis cover open : Do not operate this unit when the outer cover or front panel is open.

Use suitable fuses : Only use specified fuse types and rated specifications.

Avoid exposing circuitry : When power is on, never make contact with exposed adaptor or components.

When fault is suspected, stop operation : If you suspect a fault, ask a qualified maintenance professional to carry out inspection.

Maintain good ventilation.

Do not operate in humid condition.

Do not operate in combustible and explosive conditions.

Keep the product surface clean and dry.

Safety Messages and Symbols

Safety terminology used in this manual. The following messages may appear in this manual :

Warning : Warning statements identify conditions or practices that could result in injury or loss of life .

Caution : Caution statements identify conditions or practices that could result in damage to this unit or other properties

Messages on the product : The following messages may appear on the product :

“Danger” means potential damage that is immediate.

“Warning” means potential damage that is not immediate.

“ Caution” means possible damage to this product or other properties.

Icons on the product : The following icons may appear on the product :



High voltage



Caution! Refer to manual



Protective
ground terminal



Ground terminal
for chassis



Ground terminal
for testing

Preface

This manual provides information on the operation of the UTD2000L digital storage oscilloscope series. Guidance is given in several chapters as follows :

Chapter 1 User Guide : Simple guide to oscilloscope functions and installation.

Chapter 2 Instrument Setups : Guide to operation of the UTD2000L digital storage oscilloscope series.

Chapter 3 Practical Example Illustrations : Example illustrations are provided to solve various testing problems.

Chapter 4 System Prompts and Trouble-shooting :

Chapter 5 Servicing and Support :

Chapter 6 Appendixes :

Appendix A: Technical Indicators

Appendix B : Accessories for UTD2000L Series Digital Storage Oscilloscope

Appendix C : Maintenance and Cleaning

Appendix D: Chinese and English Cross Reference Table for the Front Panel

The UTD2000L Digital Storage Oscilloscope Series

UTD2000L oscilloscope offer user-friendliness, outstanding technical indicators and a host of advanced features. They are your perfect tools to complete testing tasks swiftly and efficiently.

This manual is a user guide for 3 models of the digital storage oscilloscope series :

Model	Bandwidth	Real-time Sampling Rate	Display
UTD2052CEL	50MHz	1GS/s	Color
UTD2102CEL	100MHz		
UTD2052CL	50MHz	500MS/s	

UTD2000L Oscilloscope offer a user-friendly front panel with clear indications to allow access to all basic functions for easy operation. The scaling and position buttons for all channels are optimally arranged for intuitive operation. As design is based on the familiar practices of traditional instruments, users can use the new units without spending considerable time in learning and familiarizing with operation. For faster adjustment to ease testing, there is a [AUTO] key to instantly display the appropriate waveform and range position.

Apart from being extremely user-friendly, UTD2000L Oscilloscope have the high performance indicators and superb functions required for speedy execution of measurement tasks. Thanks to 1GS/s (UTD2052CEL, UTD2102CEL), 500MS/s (UTD2052CL) real-time sampling and 25GS/s equivalent sampling, you can observe higher speed signals with your UTD2000L Oscilloscope. The strong trigger and analytical functions make it easy to acquire and analyse waveforms, while the sharp and clear LCD and mathematics functions ensure clear observation and reliable analysis of signal conditions.

The performance features listed below will explain why the UTD2000L series can fully satisfy your testing and measurement requirements:

- Dual analog channels; width range : 1 mV/div ~ 20V/div
- High definition color LCD system, 800 x 480 resolution
- Supports plug-and-play USB storage device. Communication with and remote control of computer through the USB device
- Automatic waveform and status configuration
- Storage of waveforms, setups and interfaces; waveforms and setups reproduction
- Fine window extension; precise analysis of waveform details and overview
- Automatic measurement of 28 waveform parameters
- Automatic cursor tracing measurement function
- Unique waveform recording and replay function
- Built-in FFT
- Multiple waveform mathematics functions (including add, subtract, multiply and divide)
- Edge, pulse width and alternate trigger functions
- Multilingual menu displays
- Help messages in English and Chinese

UTD2000L User Manual

UTD2000L accessories :

- 2 x 1.5m, 1:1/10:1 probe. For details refer to the probe instructions. These accessories conform with En61010-031 : 2002 standards
- Power line conforming to international standards applicable in the country of use
- User Manual
- Product Warranty Card
- USB connecting cable :
UT-D05 (two-terminal USB/HOST plug)
- UTD2000L oscilloscope communication control software (USB-device)

Table of Contents

Item	Page
Safety Instructions	
Preface	
Chapter 1 User Guide-----	1
General Inspection-----	5
Functional Check-----	5
Probe Compensation-----	8
Automatic Setup for Waveform Display-----	8
Getting to Know the Vertical System-----	9
Getting to Know the Horizontal System-----	10
Getting to Know the Trigger System-----	12
Chapter 2 Instrument Setups-----	14
Setting the Vertical System-----	15
Setting the Horizontal System-----	23
Setting the Trigger System-----	27
Alternate Trigger-----	31
Setting the Sampling System-----	35
Setting the Display System-----	37

Item	Page
Storage and Recall -----	38
Utility Function Setup-----	42
Automatic Measurement-----	45
Cursor Measurement -----	50
Using the Run Button-----	51
Chapter 3 Practical Example Illustrations-----	53
Illustration 1 : Measuring simple signals-----	53
Illustration 2 : Observing the delay and time-lapse caused by a sine wave signal passes through the circuit -----	54
Illustration 3 : Acquiring single signals-----	55
Illustration 4 : Reducing random noise of signals-----	56
Illustration 5 : Using the cursors for measurement-----	58
Illustration 6 : Using the X-Y function-----	59
Illustration 7 : Using the USB upgrade programme-----	60
Illustration 8 : Screen copy-----	68

Item	Page
Chapter 4 System Prompts and Trouble-shooting-----	69
Definitions of System Prompts-----	69
Troubleshooting-----	69
Chapter 5 Service and Support-----	71
Chapter 6 Technical Indicators-----	72
Appendix A: Technical indicators-----	72
Appendix B: Accessories for UTD2000L Series Digital Storage Oscilloscope -----	78
Appendix C: Maintenance and Cleaning-----	78
Index -----	79

Chapter 1 User Guide

Your UTD2000L Series digital storage oscilloscope is a small and compact benchtop device. The user-friendly front panel enables easy operation. This chapter will guide you through basic testing steps.

This chapter provides notes on the following :

- General inspection
- Functional check
- Probe compensation
- Automatic setups for waveform display
- Getting to know the vertical system
- Getting to know the horizontal system
- Getting to know the trigger system

When beginning to use your UTD2000L oscilloscope, first familiarize yourself with the operation front panel. This chapter briefly describes the operation and functions of the front panel, so you can get started with your UTD2000L series digital storage oscilloscope as quickly as possible.

Your UTD2000L oscilloscope comes with a front panel with at-a-glance

functions for easy operation. There are knobs and function keys on the front panel. The functions of knobs are similar to other Oscilloscope. On the right you will find the screen copy key (PrtSc) which enables you to save the current screen in an external USB device in picture format and 5 menu operation keys (designated as [F1] to [F5] from top down). With these keys you can set up different options of the current menu. The other keys are function keys. You can use them to enter different function menus or access particular functions directly. :



Figure 1-1 UTD2000L Series Digital Storage Oscilloscope

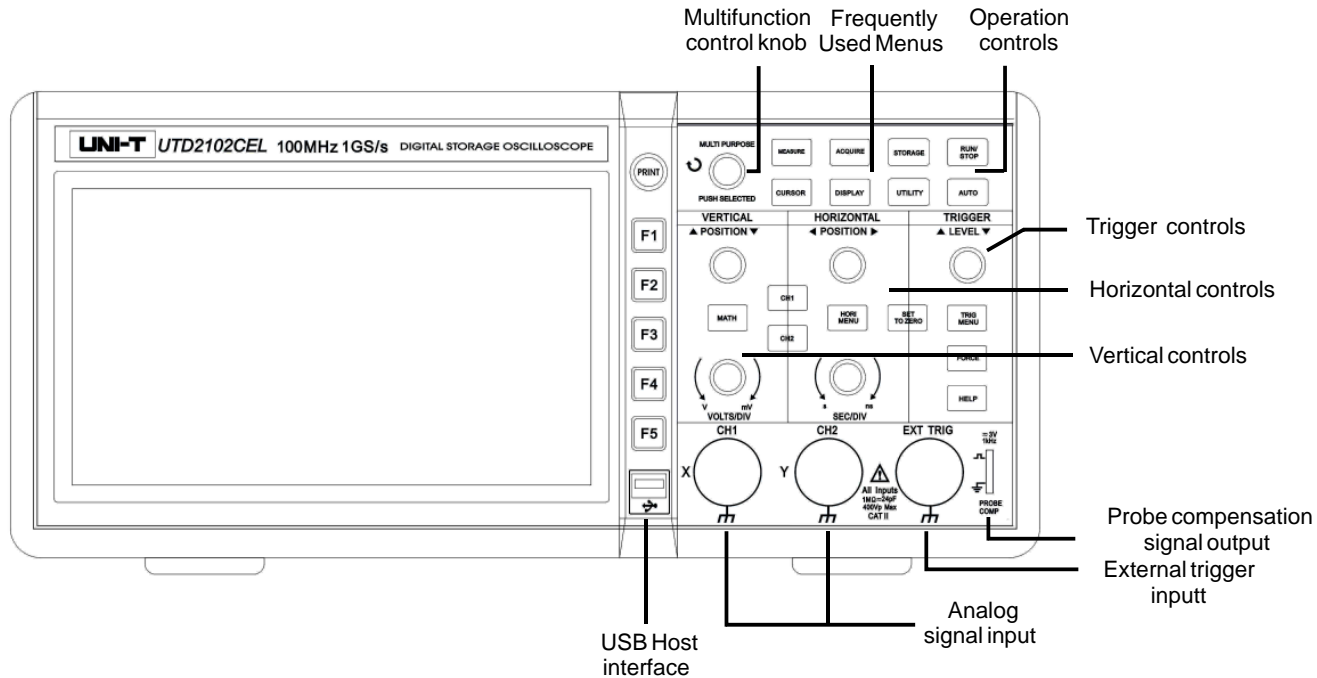

Figure 1-2 Schematic Diagram of the UTD2000L Front Panel

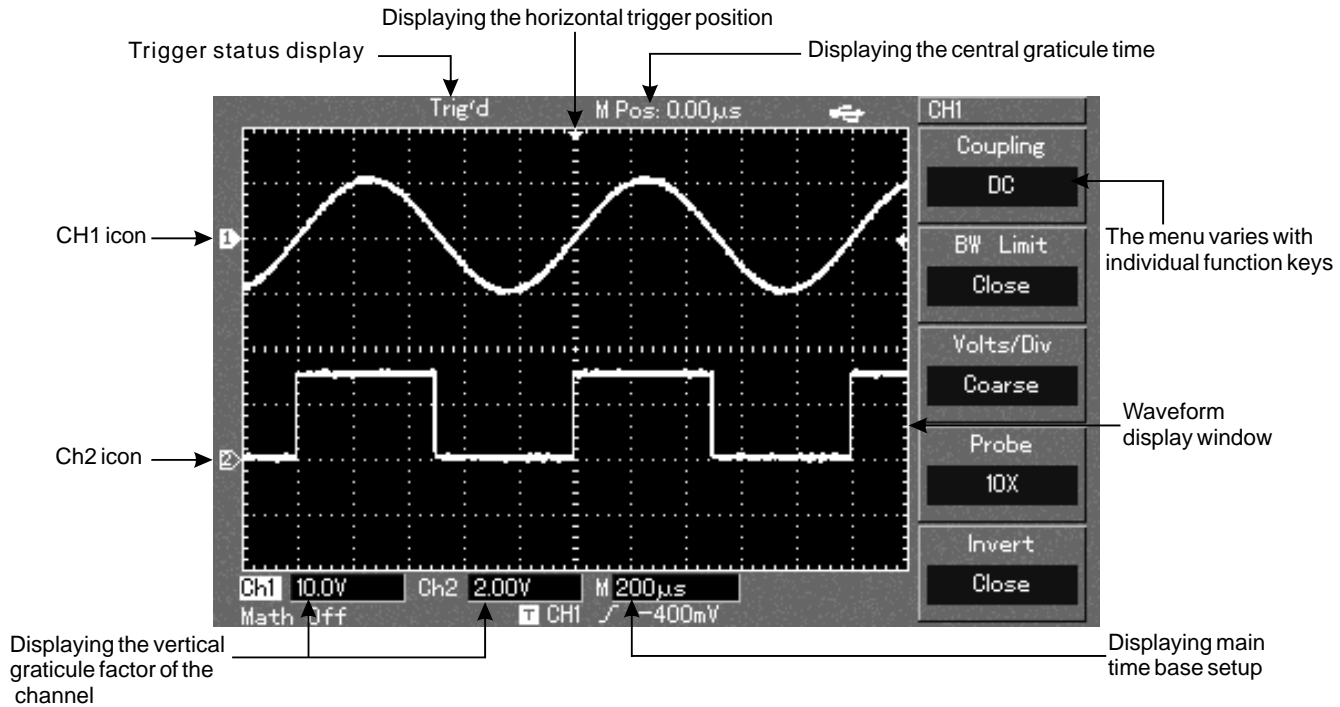

Figure 1-3 Schematic diagram of the display interface

UTD2000L User Manual

General Inspection

We suggest checking your new UTD2000L oscilloscope in the following steps.

1. Check the unit for possible shipping damages

If the package carton or foam plastic protective lining is seriously damaged, please arrange for exchange immediately.

2. Check the accessories

A checklist of accessories that come with your UTD2000L oscilloscope is provided in the section “Accessories for UTD2000L Series Digital Storage Oscilloscope” of this user manual. Please check any missing items against this list.

If any item is missing or damaged, please contact your UNI-T dealer or our local office.

3. Thorough inspection of the entire unit

If the exterior of the unit is damaged, or it is not operating normally, or it fails to pass the performance test, please contact your UNI-T dealer or our local office.

In the event of any shipping damages, please retain the packaging and notify our shipping department or your Uni-T dealer. We will be glad to arrange maintenance or repair.

Functional Check

Carry out a quick functional check in the following steps to make sure your oscilloscope is operating normally.

1. Power on the unit

Power on the unit. AC power supply voltage range is 100V AC to 240V AC, frequency 45Hz-440Hz. After connecting to power, start the self calibration process on the optimal oscilloscope signal path at greatest measurement accuracy. Press the [UTILITY] button and [F1], then press [F5] to go to the next page and press [F1]. To recall DEFAULT SETUP, see Figure 1-4.

After completing the above steps, press [CH1] to enter the CH1 menu.

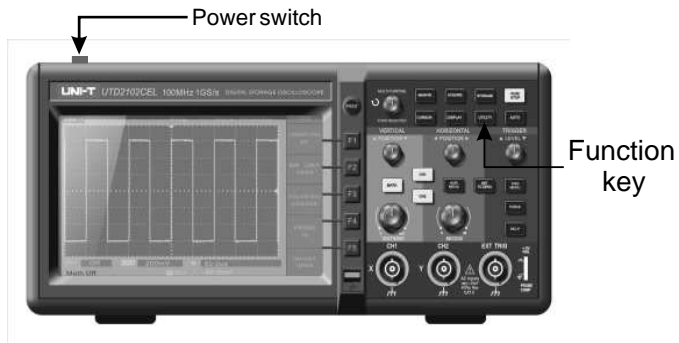

Figure 1-4

Warning : To avoid danger, ensure the digital storage oscilloscope is safely grounded.

2. Accessing signals

Your UTD2000L oscilloscope has dual input channels and an external trigger input channel. Please access signals in the following steps:

- ① Connect the probe of the digital storage oscilloscope to the CH1 input terminal, and set the attenuation switch of the probe to 10X (Figure 1-5).

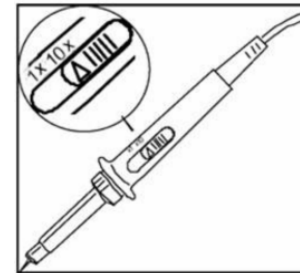

Figure 1-5 Setting the attenuation switch of the probe

UTD2000L User Manual

② You have to set the probe attenuation factor of the oscilloscope. This factor changes the vertical range multiple to ensure the measurement result correctly reflects the amplitude of the signal being tested. Set the attenuation factor of the probe as follows : Press [F4] to show 10X on the menu.

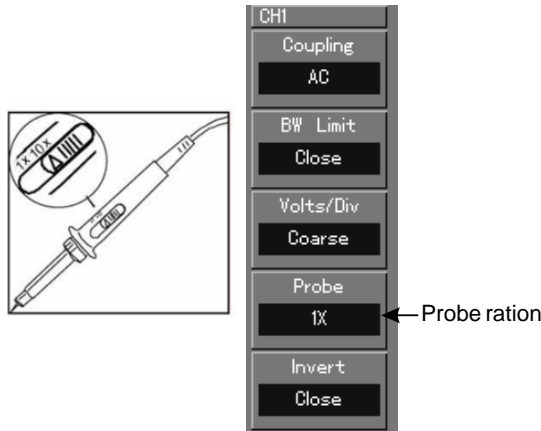

Figure 1-6 Setting the deflection factor of the oscilloscope probe

③ Connect the probe tip and ground clamp to the connection terminal for the probe compensation signal. Press [AUTO] and you will see a square wave in the display (1kHz, approximately 3V, peak-to-peak value) in a few seconds, as shown in Figure 1-7. Use the same method to check CH2. Press function key [CH1] again to close CH1. Press function key [CH2] to activate CH2 and repeat steps 2 and 3.

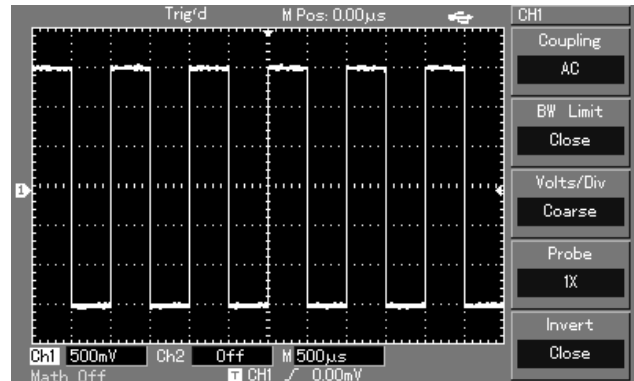

Figure 1-7 Probe compensation signal

Probe Compensation

When connecting the probe to any input channel for the first time, perform this adjustment to match the probe to the channel. Skipping the compensation calibration step will result in measurement error or fault. Please adjust probe compensation as follows :

1. Set the probe attenuation factor to 10X. Move the switch on the probe to 10X and connect the probe to CH1. When using a hook-tip, ensure it is well connected to the probe. Connect the probe tip to the output terminal of the probe compensator's signal connector, and the ground clamp to the ground cable connector of the probe compensator. Activate CH1 then press [AUTO].
2. **Observe the displayed waveform.**



Overcompensation Correct Compensation Undercompensation

Figure 1-8 Probe compensation calibration

3. If you see an “Undercompensation” or “Overcompensation” waveform display , adjust the adjustable capacitance tab of the probe with a screwdriver with non-metal handle , until a “Correct Compensation” waveform shown in the above figure is displayed.

Warning : To avoid electric shock when measuring high voltage with the probe, ensure the probe's insulation lead is in good condition. Do not touch the metal part of the probe when connected to HV power.

Automatic Setup for Waveform Display

Your UTD2000L oscilloscope features an auto setup function . It can automatically adjust the vertical deflection factor, scanning time base and trigger mode based on the input signal, until the most appropriate waveform is displayed. The auto setup function can only be operated when the signal to be measured is 20Hz or above and the duty ratio is larger than 1%.

Using the Auto Setup Function :

1. Connect the signal to be tested to the signal input channel.
2. Press [AUTO]. The oscilloscope will automatically set the vertical deflection factor, scanning time base and trigger mode.

UTD2000L User Manual

Should you require to make more detailed check, you can adjust manually after the auto setup process until you get the optimal waveform display.

Getting to Know the Vertical System

As shown in the figure below, there are a group of buttons and knobs in the vertical control zone. The following exercise will guide you through vertical setup.



Figure 1-9 Vertical control zone on the front panel

1. Turn the vertical position knob to display the signal in the centre of the window. The vertical position knob controls the vertical display position of the signal.
When you turn the vertical position knob, the sign indicating the [GROUND] channel will move up and down with the waveform.

Measurement Tips :

If the channel coupling is DC, you can measure the signal's DC% quickly by checking the difference between the waveform and signal ground.

In the case of AC coupling, the DC% within the signal will be filtered. With this coupling mode you can display the AC% of the signal with higher sensitivity.

Shortcut key for resetting to zero :

[SET TO ZERO]

This shortcut key can reset vertical shift, horizontal shift and holdoff to the zero position (center point), and set the trigger level to 50%.

2. Change the vertical setup and observe changes of status information.
You can identify changes of any vertical range by reading the status display column at the lower corner of the waveform window. Turn the vertical SCALE knob to change the vertical VOLT/DIV range. You will find that the range in the corresponding channel has changed accordingly. Press [CH1], [CH2] or [MATH] and the screen will show the corresponding operation menu, sign, waveform and range status information. Press the corresponding button for the currently activate channel again to close the selected channel.

Getting to Know the Horizontal System

As shown in the figure below, there are one button and two knobs in the horizontal control zone. The following steps will get you familiar with horizontal time base setup.



Figure 1-10 Horizontal control zone on the front panel

UTD2000L User Manual

1. Use the horizontal SCALE knob to change the horizontal time base range setup and check any changes in time base range. Turn the horizontal SCALE knob to change the SEC/DIV time base range. You will find that the time base range in the current status column has changed accordingly. Range of horizontal scanning rate is 2ns~50s, in steps of 1-2-5.

* Note : Horizontal scanning time base range of the UTD2000L Series varies from model to model.

2. Use the horizontal POSITION knob to adjust the signal's horizontal position of the waveform window. The horizontal POSITION knob controls trigger shift of the signal. When this function is used for trigger shift and the horizontal POSITION knob is turned, you can see that the waveform moves horizontally with the knob.
3. Press [HORI MENU] to display the ZOOM menu. In this menu press [F3] to activate window expansion. Then press [F1] to quit window expansion and return to the main time base. You can also set the holdoff time with this menu.

Shortcut key for resetting trigger point displacement to horizontal zero :

The shortcut key [SET TO ZERO] can quickly reset the trigger point to the vertical centre point. You can also turn the horizontal POSITION knob to adjust the horizontal position of the signal in the waveform window .

Definition

Trigger point means the actual trigger point relative to the centre point of the storage device. By turning the horizontal POSITION knob , you can move the trigger point horizontally.

Holdoff means reactivating the time interval of the trigger circuit. Turn the multifunction control knob to set the holdoff time.

Getting to Know the Trigger System

As shown in Figure 1-11, there are one knob and three buttons in the trigger menu control zone. The following steps will get you familiar with trigger setup.



Figure 1-11 Trigger menu control zone on the front panel

1. Use the trigger level knob to change the trigger level. You will see a trigger sign on the screen that indicates the trigger level. The sign will move up and down with the knob. While you move the trigger level, you will find the trigger level value at the bottom of the screen changing accordingly.
2. Open the [TRIGGER MENU] (see Figure 1-12) to change trigger setup.
Press [F1] and select RISING for { TYPE } .
Press [F2] and select CH1 for { TRIGGER SOURCE } .
Press [F3] and set RISING for { SLEW RATE } .
Press [F4] and set AUTO for { TRIGGER MODE } .
Press [F5] and set AC for { TRIGGER COUPLING } .



Figure 1-12 Trigger Menu

3. Press [SET TO ZERO] to set the trigger level at the vertical centre point of the trigger signal amplitude .
4. Press [FORCE] to generate a compulsory trigger signal that is mainly used in the normal and single trigger modes.

Chapter 2 Instrument Setups

You should be familiar with basic operation of the vertical controls, horizontal controls and trigger system menu of your UTD2000L Series oscilloscope by now. After reading the last chapter, you should be able to use the menus to set up your digital storage oscilloscope. If you are still unfamiliar with these basic operation steps and methods, please read Chapter 1.

This chapter will guide you through the following :

- Setting the vertical system ([CH1], [CH2], [MATH], [VERTICAL POSITION], [VERTICAL SCALE])
- Setting the horizontal system ([HORI MENU], [HORIZONTAL POSITION], [HORIZONTAL SCALE])
- Setting the Trigger system ([TRIGGER LEVEL], [TRIG MENU], [FORCE])
- Setting the sampling method ([ACQUIRE])
- Setting the display mode ([DISPLAY])
- Storage and recall ([STORAGE])

- Setting the help system ([UTILITY])
- Automatic measurement ([MEASURE])
- Cursor measurement ([CURSOR])
- Using the execution buttons ([AUTO], [RUN/STOP])

It is recommended that you read this chapter carefully to understand the various measurement functions and system operation steps of your UTD2000L Series oscilloscope .

Setting the Vertical System

CH1, CH2 and setups

Each vertical channel has its own vertical menu. You should set up each item for each channel individually. Press the [CH1] or [CH2] function button and the system will display the operation menu for CH1 or CH2. For explanatory notes please see Table 2-1 below :

Table 2-1 : Explanatory notes for channel menu

Function Menu	Setup	Explanatory Note
Coupling	AC DC GND	Intercept the DC quantities of the input signal Pass AC and DC quantities of input signal Disconnect input signal
BW Limit	Open Close	Limit bandwidth to 20MHz to reduce noise display Full bandwidth
Volts/Div	Coarse Fine	Coarse tune in steps of 1-2-5 to set up the deflection factor of the vertical system Fine tune means further tuning within the coarse tune setup range to improve the vertical pixel aspect ratio
Probe	1x 10x 100x 1000x	Select either one value based on the probe attenuation factor to keep the vertical deflection factor reading correct. There are four values : 1x, 10x, 100x and 1000x
Invert	Open Close	Waveform invert function on Normal waveform display

1. Setting the channel coupling :

Take an example of applying a signal to CH1. The signal being tested is a sine signal that contains DC quantities.

Press [F1] to select AC. It is now set up as AC coupling. DC quantities of the signal being tested will be intercepted. The waveform display is as follows :

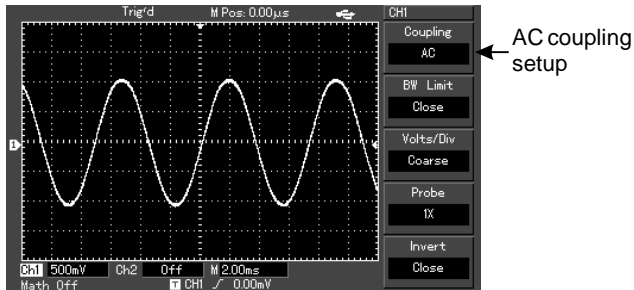

Figure 2-1 DC quantities of the signal are intercepted

Press [F1] to select DC. Both DC and AC quantities of the testing signal being inputted to CH1 can pass through. The waveform display is as follows :

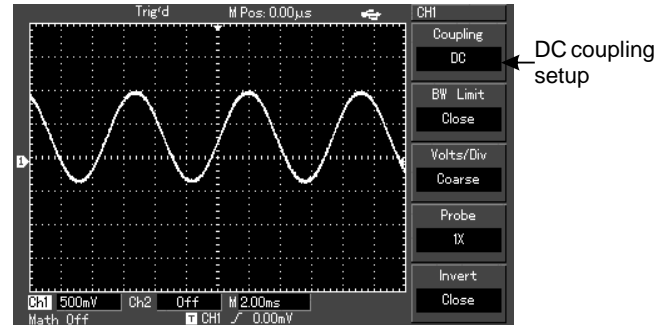

Figure 2-2 Both DC and AC quantities of the signal are displayed

UTD2000L User Manual

Press [F1] to select GROUND. It is now set up as ground. The display is as follows :

(Note: in this mode, although waveform is not displayed, the signal remains connected to the channel circuit)

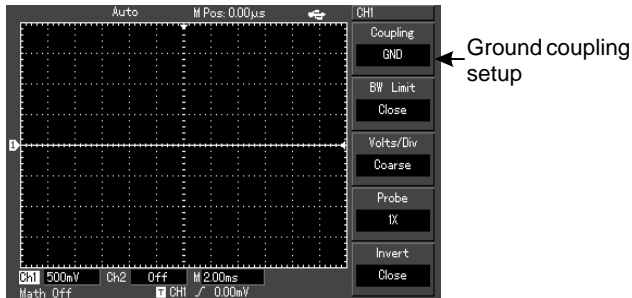

Figure 2-3 Screen display in ground mode

2. Setting channel bandwidth suppression :

Bandwidth suppression can suppress high frequency quantities over 20MHz or noise in the signal being tested. Application is as follows :

Press [CH1] to turn CH1 on. Then press [F2] to set BANDWIDTH SUPPRESSION OFF. It is now set up as full bandwidth. The signal being measured can pass through even if it contains high frequency quantities. The waveform display is as follows :

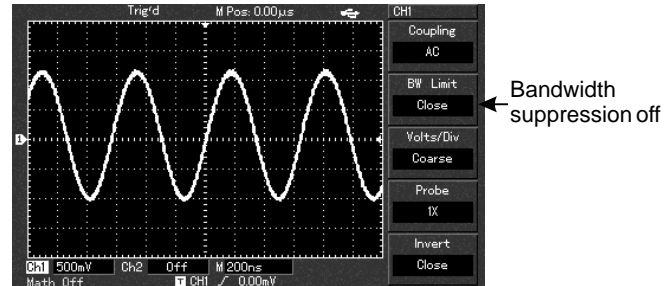
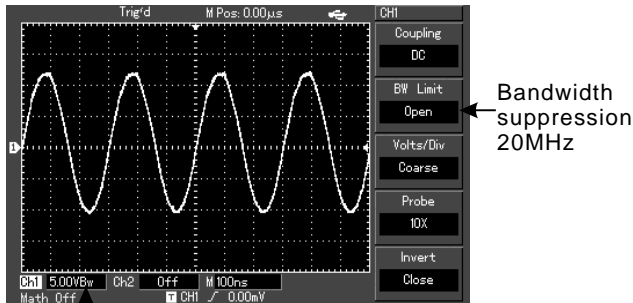

Figure 2-4 Waveform display when bandwidth suppression is off

Press [F2] to set BANDWIDTH SUPPRESSION ON. All high frequency quantities higher than 20MHz in the signal being tested will be limited. The waveform display is as follows :



Bandwidth suppression icon

Figure 2-5 Waveform display when bandwidth suppression is on

3. Setting the probe rate :

To match the probe attenuation factor setup, it is necessary to set up the PROBE attenuation factor in the channel operation menu accordingly. For example, when the probe attenuation factor is 10:1, set the probe attenuation factor at 10X in the menu. Apply this principle to other values to ensure the voltage reading is correct.

The figure below shows the setup and vertical range display when the probe is set at 10:1.

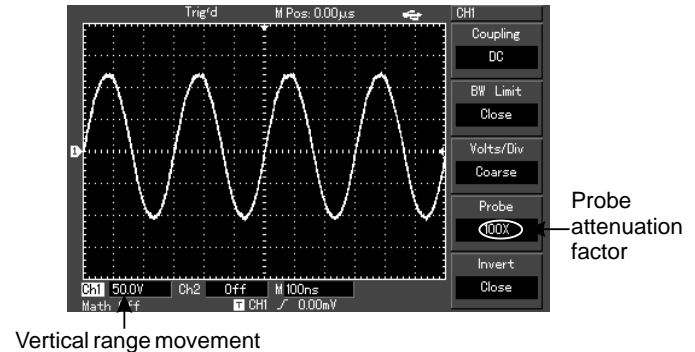

Figure 2-6 Setting the probe attenuation factor in the channel menu

4. Vertical VOLTS/DIV adjustment setup :

You can adjust the VOLTS/DIV range of the vertical deflection factor either in the coarse tune mode or fine tune mode. In COARSE TUNE mode, the VOLTS/DIV range is 1mV/div~20V/div. Tuning is in steps of 1-2-5. In FINE TUNE mode, you can change the deflection factor in even smaller steps within the current vertical range, so as to continuously adjust the vertical deflection factor within the range of 1mV/div~20V/div without interruption.

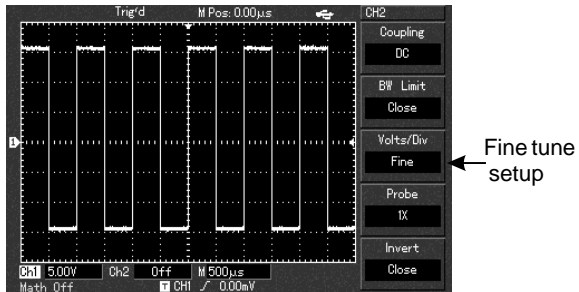
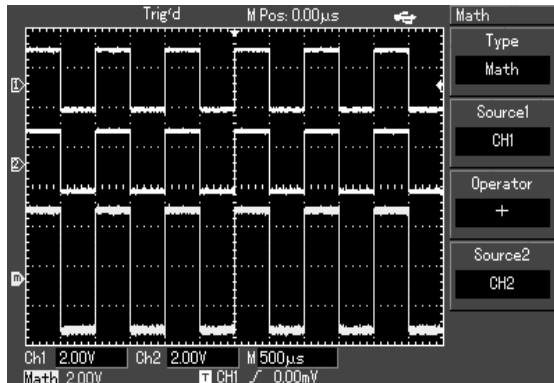

Figure 2-7 Coarse tuning and fine tuning the vertical deflection factor

I. Operating Math Functions

Math functions are displays of +, -, x, / and FFT mathematical results of CH1 and CH2 waveforms. The menu is as follows :



Math range

Figure 2-10 Math functions

Table 2-2 : Explanatory notes for the Math menu

Function Menu	Setup	Explanatory Note
Type	Math	To carry out +, -, x, / functions
Source 1	Ch1	Set signal source 1 as CH1 waveform
	Ch2	Set signal source 1 as CH2 waveform
Operator	+	Signal source 1 + Signal source 2
	-	Signal source 1 - Signal source 2
	x	Signal source 1 x Signal source 2
	/	Signal source 1 / Signal source 2
Source 2	Ch1	Set signal source 2 as CH1 waveform
	Ch2	Set signal source 2 as CH2 waveform

FFT spectrum analysis

By using the FFT (Fast Fourier Transform) algorithm, you can convert time domain signals (YT) into frequency domain signals. With FFT, you can conveniently observe the following types of signals :

- Measure the harmonic wave composition and distortion of the signal
- Measure the noise characteristics of the DC power
- Analyse oscillation

Table 2-3 Explanatory notes for the FFT menu

Function Menu	Setup	Explanatory Note
Type	FFT	To carry out FFT algorithm functions
Source	Ch1 Ch2	Set CH1 as math waveform Set CH2 as math waveform
Window	Hanning Hamming Blackman Rectangle	Set Hanning window function Set Hamming window function Set Blackman window function Set Rectangle window function
Vertical	Vrms dBVrms	Set the vertical unit to Vrms or dBVrms

How to use FFT functions

Signals with DC quantities or DC offset will cause error or offset of FFT waveform quantities. To reduce DC quantities, select AC coupling. To reduce random noise and frequency aliasing resulted by repeated or single pulse event, set the acquiring mode of your oscilloscope to average acquisition.

Select the FFT Window

Assuming the YT waveform is constantly repeating itself, the oscilloscope will carry out FFT conversion of time record of a limited length. When this cycle is a whole number, the YT waveform will have the same amplitude at the start and finish. There is no waveform interruption. However, if the YT waveform cycle is not a whole number, there will be different amplitudes at the start and finish, resulting in transient interruption of high frequency at the connection point. In frequency domain, this is known as leakage. To avoid leakage, multiply the original waveform by one window function to set the value to 0 for start and finish compulsively. For application of the window function, please see the table below :

Table 2-4

FFT Window	Feature	Most Suitable Measurement Item
Rectangle	The best frequency recognition rate, the worst amplitude recognition rate. Basically similar to a status without adding window.y recognition rate, the worst amplitude recognition rate. Basically similar to a status without adding window.	Temporary or fast pulse. Signal level is generally the same before and after. Equal sine wave of very similar frequency. There is broad-band random noise with slow moving wave spectrum.
Hanning	Frequency recognition rate is better than the rectangle window, but amplitude recognition rate is poorer.	Sine, cyclical and narrow-band random noise.
Hamming	Frequency recognition rate is marginally better than Hanning window.	Temporary or fast pulse. Signal level varies greatly before and after.
Blackman	The best amplitude recognition rate and the poorest frequency recognition rate.	Mainly for single-frequency signals to search for higher-order harmonic wave.

Definition :

FTT recognition rate means the quotient of the sampling and math points. When math point value is fixed, the lower the sampling rate the better FTT recognition rate you get.

Nyquist frequency : To rebuild the original waveform, at least $2f$ sampling rate should be used for waveform with a maximum frequency of f . This is known as Nyquist stability criterion, where f is the Nyquist frequency and $2f$ is the Nyquist sampling rate.

Setting the Horizontal System

The horizontal shift knob

You can move the waveform on the screen with the horizontal shift knob. By turning it clockwise, you can shift the waveform to the left to see more pre-trigger signals. Contrarily, turning it anticlockwise can display more post-trigger signals.

Horizontal scaling : Adjust the main time base, i.e s/div. When time base extension is on, you can use the horizontal scaling knob to change the window width. For details see notes on time base extension.

Horizontal control knob menu : Display the horizontal menu (see the table below).

Table 2-5

Function Menu	Setup	Explanatory Note
Main		1. Open the main time base. 2. If you press the main time base when window extension is on, window extension will close.
—		
Window		Open time base extension.
—		
Hold off		Adjust holdoff time.



Figure 2-11 Horizontal system control zone

Icon definitions :

- ① The distance between the triggering position and horizontal centre point (time).
- ② Represents the memory position of the triggering point.
- ③ Represents the trigger level of the current waveform.
- ④ Horizontal time base (main time base), i.e. s/div.

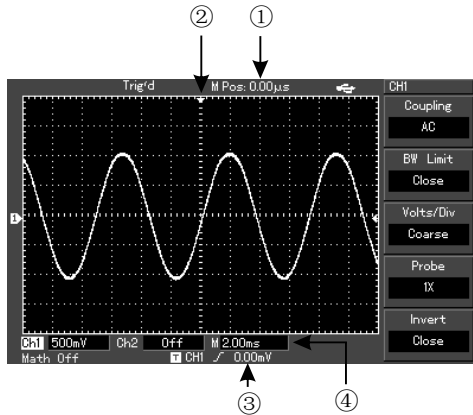

Figure 2-12 Display of horizontal parameters

Definitions

Y-T Mode : In this mode the Y axis indicates voltage and the X axis indicates time.

X-Y Mode : In this mode the X axis indicates CH1 voltage and the Y axis indicates CH2 voltage.

Slow Scanning Mode : When horizontal time base control is set at 50ms/div or slower, the unit will operate in the slow scan sampling mode. When observing low frequency signals in slow scanning mode, it is advised to set the channel coupling as DC. **S/div** : A horizontal scaling (time base) unit. If waveform sampling is stopped (by pressing the [RUN/STOP] button), time base control can expand or compress the waveform.

Window Extension

Window extension can be used to zoom in a band of waveform to check image details. Please refer to Figure 2-13.

UTD2000L User Manual

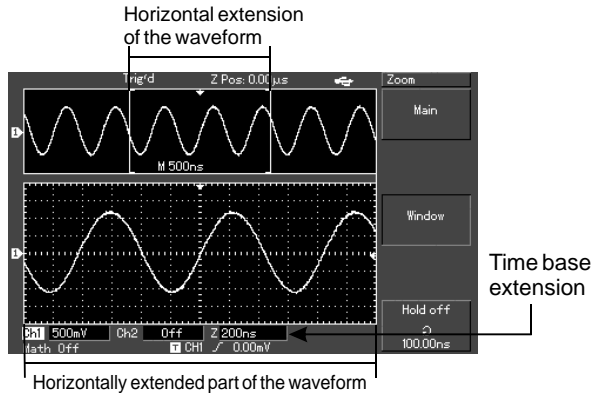

Figure 2-13 Display with the window extended

In the time base extension mode, the display is divided into two zones as shown above. The upper part displays the original waveform. You can move this zone left and right by turning the horizontal POSITION knob, or increase and decrease the selected zone in size by turning the horizontal SCALE knob.

The lower part is the horizontally extended waveform of the selected original waveform zone. Please note that the recognition rate of

extended time base relative to the main time base is now higher (as shown in the above figure). Since the waveform shown in the entire lower part corresponds to the selected zone in the upper part, you can increase the extended time base by turning the horizontal SCALE knob to decrease the size of the selected zone. In other words, you can increase the multiple of waveform extension.

X-Y Mode

This mode is suitable for CH1 and CH2 only. After selecting the X-Y display mode, the horizontal axis will display CH1 voltage, while the vertical axis will display CH2 voltage.

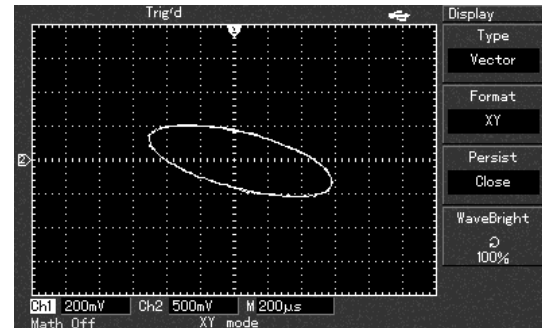

Figure 2-14 Waveform display in X-Y mod

Caution : In the normal X-Y mode, the oscilloscope can use the random sampling rate to acquire waveforms. To adjust sampling rate and channel vertical range in the X-Y mode and to adjust the time range, the omitted sampling rate is 100MS/s. Generally, lower the sampling rate appropriately will result in lissajous figures of better display quality. The following functions have different effects in the X-Y display mode :

- Automatic measurement mode
- Cursor measurement mode
- Reference or math waveform
- Vector display type
- Horizontal MENU knob
- Trigger control

Setting the Trigger System

Triggering decides when the oscilloscope collects data and display waveforms. Once the trigger is correctly set up, it can transform unstable displays into meaningful waveforms. When beginning to acquire data, the digital storage oscilloscope first collects sufficient data required for drawing a waveform on the left side of the trigger point. While waiting for the trigger condition to mature, your oscilloscope will acquire data continuously. When trigger is detected, it will continue to acquire sufficient data to draw a waveform on the right side of the trigger point. The trigger control zone on the operation panel of your oscilloscope comprises a trigger level adjustment knob, a trigger menu button [TRIG MENU], the [SET TO ZERO] button for setting the trigger level to the vertical centre point of the signal, and a compulsory trigger button [FORCE].

Trigger level : Trigger level is set to a signal voltage that matches the trigger point.

[SET TO ZERO] : Trigger level is set to the vertical centre point of the signal.

[FORCE]: To generate a trigger signal compulsorily. This button is used mainly in the trigger mode and “normal” and “single” mode.

[TRIG MENU] : Button for the trigger setup menu.

Trigger Control

Trigger modes : edge, pulse and alternate.

Edge Trigger

When the edge of the trigger signal reaches a given level, trigger occurs.

Pulse Width Trigger

When the pulse width of the trigger signal reaches a preset trigger condition, trigger occurs.

Alternate Trigger

Applicable to triggering signals without frequency coherence.

Below are notes for various trigger menus.

Edge Trigger

Edge trigger means triggering at the trigger threshold of the input signal edge. When selecting “edge trigger”, you are triggering at the rising and falling edges of the input signal.

Table 2-6

FFT Window	Feature	Most Suitable Measurement Item
Type	Edge	
Source	CH1 CH2 EXT AC Line Alter	Set CH1 as the signal source trigger signal Set CH2 as the signal source trigger signal Set the external trigger input channel as the signal source trigger signal Set up as grid trigger Ch1, CH2 trigger their own signals alternately
Slope	Rise Fall Rise & Fall	Set to trigger on the signal 's rising edge Set to trigger on the signal 's falling edge Set to trigger on the signal 's rising and falling edges
Mode	Auto Normal Single	Set to sample waveform only if no trigger condition is detected Set to sampling waveform only when trigger condition is met Set to sample waveform once when detecting one trigger and then stop
Coupling	DC AC HF Reject LF Reject	Allow AC and DC quantities of the input signal to pass Intercept DC quantities of the input signal Reject high frequency quantities above 80kHz of the signal Reject low frequency quantities below 80kHz of the signal

Note :

With regard to edge and pulse width trigger, the oscilloscope will determine the trigger frequency based on the number of trigger occurrences. When main frequency counter is on, display comes up at the top right corner. To maintain a stable trigger frequency, a larger trigger signal range is required.

Pulse Width Trigger

Pulse width trigger means determining the triggering time based on the trigger width. You can acquire abnormal pulse by setting the pulse width condition.

Table 2-7(P.1)

Function Menu	Setup	Explanatory Note
Type	Pulse	
Source	CH1 CH2 EXT AC Line Alter	Set CH1 as the signal source trigger signal Set CH2 as the signal source trigger signal Set the external trigger input channel as the signal source trigger signal Set up as grid trigger CH1, CH2 trigger signals alternately
When	> < =	Trigger when pulse width is larger than default value Trigger when pulse width is smaller than default value Trigger when pulse width equals to default value
Setting	20ns ~ 10s	Set the pulse width at 20ns~10s and adjust by turning the multifunction control knob on the upper front panel
Next ½		Move to next page

Table 2-8

Function Menu	Setup	Explanatory Note
Type	Pulse	
Polarity	Positive Negative	Set positive pulse width as the trigger signal Set negative pulse width as the trigger signal
Mode	Auto Normal Single	The system automatically samples waveform data when there is no trigger signal input. The scan baseline is shown on the display. When the trigger signal is generated, it automatically turns to trigger scan The system stops acquiring data when there is no trigger signal. When the trigger signal is generated, trigger scan occurs One trigger scan will occur when there is an input trigger signal. Then trigger will stop
Coupling	DC AC HF Reject LF Reject	Allow AC and DC quantities of the trigger signal to pass Intercept DC quantities of the trigger signal Intercept high frequency quantities of the signal, only allow low frequency quantities to pass Intercept low frequency quantities of the signal, only allow high frequency quantities to pass
Next page2/2	—	Return to previous page

Alternate Trigger

When alternate trigger is selected, the trigger signal will be present in two vertical channels. This triggering mode is suitable for observing two signals of unrelated signal frequencies. The figure below shows the alternate trigger waveform. Alternate trigger menu is listed in Table 2-9.

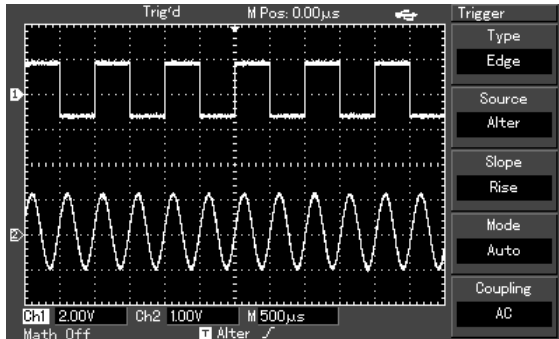

Figure 2-15 Observing two signals of different frequencies in the alternate trigger mode

Table 2-9 Alternate trigger mode setup

Function Menu	Setup	Explanatory Note
Type	Edge	Set trigger mode to edge
Source	Alter	Open time base extension.
Inclination	Rise	Set trigger inclination as rising edge
Mode	Auto	Set trigger mode to automatic
Coupling	AC	Set trigger coupling mode to AC

“Alternate trigger” can also be used to compare pulse width

Setup for Trigger coupling mode

Enter the trigger setup menu to set up the trigger coupling mode and achieve the most stable synchronization. The trigger coupling menu is as follows :

Table 2-10

FFT Window	Feature	Most Suitable Measurement Item
Type	Edge	
Source	Alter	Set CH1 an CH2 to alternate trigger
Slope	Rise	Set trigger Inclination as rising edge
Mode	Auto	Set trigger mode to automatic
Coupling	DC AC HF Reject	Intercept DC quantities to pass Allow all quantities to pass Intercept high frequency quantities of the signal, only allow low frequency quantities to pass
	LF Reject	Intercept low frequency quantities of the signal, only allow high frequency quantities to pass

Adjusting the Holdoff Time

You can adjust the holdoff time to observe complicated waveforms (e.g. pulse string series). Holdoff time means the waiting time for the trigger circuit to be ready for use again when the oscilloscope is restarted. During this time the oscilloscope will not trigger until the holdoff is complete. For example, if you wish to trigger one group of pulse series at the first pulse, set the holdoff time to the pulse string width as shown in Figure 2-16. For holdoff menu please see the table below :

Table 2-11

Function Menu	Setup	Explanatory Note
Main	—	1. Enable main time base 2. If window extension is enabled, press main time base to disable window extension
—		
Window		Enable time base extension
—		
Hold off		Adjust holdoff time.

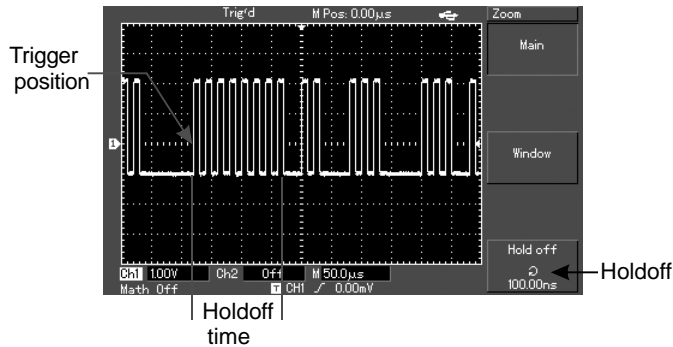

Figure 2-16 Use the holdoff function to synchronize complicated waveforms

Operation

1. Follow the normal signal synchronization procedure and select the edge, trigger source and inclination in [TRIG MENU]. Adjust the trigger level to make the waveform display as stable as possible.
2. Press the horizontal [HORI MENU] key to display the horizontal menu.

3. Adjust the multifunction control knob in the upper front panel. The holdoff time will change accordingly until the waveform display is stable.

Definitions

1. Trigger source : Trigger can be obtained from various signal sources : Input channel (CH1, Ch2), external trigger (EXT), LINE.
 - Input Channel : The most common trigger source is vertical channel (choose either one). The channel selected as trigger source can operate normally whether the input is displayed or not.
 - External Trigger : This type of trigger source can trigger in a third channel while acquiring data in two other channels. For example, you can use an external clock or the signal from a circuit to be tested as the trigger source. EXT trigger source uses external trigger signals from the EXT TRIG adaptor. EXT can use the signals directly. You can use EXT within the trigger level range of -3V and +3V.
 - LINE : means the grid power source. This trigger mode is suitable for observing signals related to the grid e.g. the correlation between lighting equipment and power source equipment to achieve stable synchronization.

2. **Trigger mode** : Determine the action of your oscilloscope at no trigger. This oscilloscope offers three trigger modes for selection : auto, normal and single.
 - **Auto Trigger** : The system will acquire waveform data automatically when there is no trigger signal input. The scan baseline is shown on the display. When the trigger signal is generated, it automatically turns to trigger scan for signal synchronization.
Note : When time base of the scan range is set to 50ms/div or slower, the “Auto” mode allows no trigger signal.
 - **Normal Trigger** : In this mode, your oscilloscope samples waveforms only when triggering conditions are met. The system stops acquiring data and waits when there is no trigger signal. When the trigger signal is generated, trigger scan occurs.
 - **Single Trigger** : In this mode, you only have to press the “Run” button once and the oscilloscope will wait for trigger. One sampling will occur and the acquired waveform will be displayed when the digital storage oscilloscope detects a trigger. Then trigger will stop.
3. **Trigger coupling** : Trigger coupling determines which quantities of the signal are transmitted to the trigger circuit. Coupling modes are DC, AC, low frequency suppression and high frequency suppression.
 - **DC** : Allowing all quantities to pass.
 - **AC** : Intercepting DC quantities and attenuating signals under 10Hz.
 - **Low Frequency Suppression** : Intercepting DC quantities and attenuating low frequency quantities under 80kHz.
 - **High Frequency Suppression** : Attenuating high frequency quantities over 80kHz.
4. **Pretrigger/Delayed Trigger** : Data sampled before/after triggering.
The trigger position is typically set at the horizontal center of the screen. In this case, you are able to view 6 divisions of pretrigger and delayed information. Turning the horizontal position of the waveform allows you to adjust the horizontal displacement of the waveform. By observing pretrigger data, you can see the waveform before trigger occurs. For example, you can detect the glitch that occurs when the circuitry starts. Observation and analysis of pretrigger data can help you identify the cause of glitch.

UTD2000L User Manual

Setting the Sampling System

As shown below, [ACQUIRE] button in the control zone is the function key for the sampling system.



Figure 2-17 Function key for the sampling system

Press the [ACQUIRE] button to pop out the sampling setup menu. You can use this menu to adjust the sampling mode.

Table 2-12 Sampling menu

Function Menu	Setup	Explanatory Note
Mode	Sample Peak Average	Turn on the ordinary sampling mode Turn on the peak detect mode Set to average sampling and display the average number of times
Average	2~256	Set the average number of times in multiples of 2, i.e. 2, 4, 8, 16, 32, 64, 128, 256. To change the average number of times, use the multifunction control knob on the left of Figure 2-16
—		
Sampling	Real time Equ-time	Set sampling to real time sampling Set sampling to equivalent sampling
FastACQ	ON OFF	Quick acquisition function is on Quick acquisition function is off

By changing the acquisition setup, you can observe the consequent changes in waveform display. If the signal contains considerable noise, you will see the following displays when average sampling is not selected and when 64-time average sampling is selected. For sampling waveform display please see Figure 2-18 and Figure 2-19.

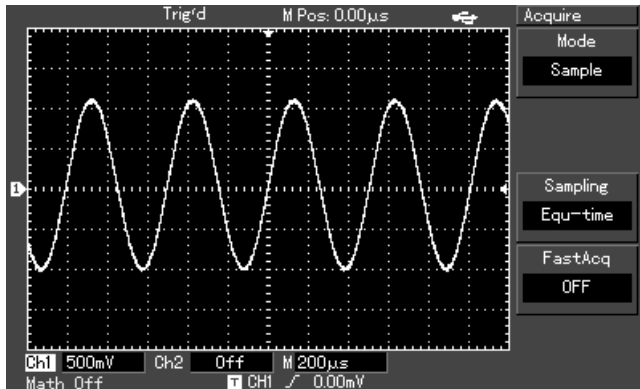

Figure 2-18 Waveform without average sampling

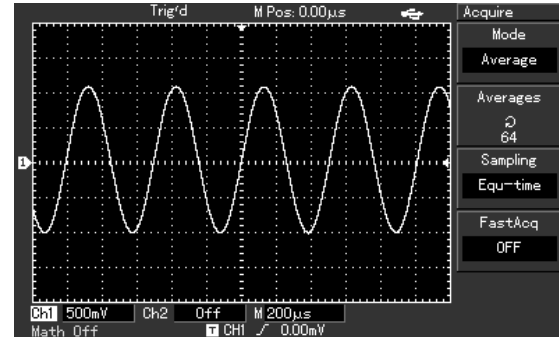

Figure 2-19 Waveform when 64-time average sampling is selected

Notes :

1. Use Real time sampling to observe single signals.
2. Use Equivalent sampling to observe high frequency cyclical signals.
3. To avoid mixed envelop when observing a signal, select Peak Detect. To reduce random noise of the displayed signal, select average sampling and increase the average number of times in multiples of 2, i.e selecting from 2 to 256.

UTD2000L User Manual

Definitions :

Real time sampling : In this mode, the system makes full acquisition to fill the memory. Maximum real time sampling rate is 500MS/s(UTD2052CL). At a setting of 50ns or faster, the oscilloscope will automatically carry out interpolation, i.e. inserting a sampling point between other sampling points.

Equivalent sampling : This is a repeated sampling mode that allows detailed observation of repeated cyclical signals. In the equivalent sampling mode, the horizontal pixel aspect ratio is 40ps higher than the real time mode, i.e. 25GS/s equivalent.

Sampling mode : Your oscilloscope acquires signal samples at equal time intervals to reconstruct waveform.

Peak detect mode : In this acquisition mode, the oscilloscope identifies the biggest and smallest values of the input signals at each sampling interval and use these values to display the waveform. In effect, the oscilloscope can acquire and display narrow pulse which would otherwise be omitted in the sampling mode. Noise seems to be more significant in this mode.

Average mode : The oscilloscope acquires several waveforms and take the average value to display the final waveform. You can use this mode to reduce random noise.

Setting the Display System

As shown below, the [DISPLAY] button in the control zone is the function key for the display system.



Figure 2-20 Function key for the sampling system (display)

Press the [DISPLAY] button to pop out the setup menu shown below. You can use this menu to adjust the display mode.

Table 2-13 Display menu

Function Menu	Setup	Explanatory Note
Type	Vector	Sampling points are linked for display Only sampling points are displayed
Format	YT XY	Operating mode of the oscilloscope X-Y is the display mode ; CH1 is X input , CH2 is Y input
Persist	Close 1s 2s 5s Infinite	The waveform on the screen is refreshed at a fast rate ; The waveform on the screen is refreshed at 1s ; The waveform on the screen is refreshed at 2s ; The waveform on the screen is refreshed at 5s ; The original waveform on the screen remains on display. New data will be added continuously until this function is disabled.
WaveformBright	1%-100%	Setting the waveform brightness

Key points :

Display Type : Vector dots fill the space between adjacent sample points in the display. Dots display only the sampling points.

Storage and Recall

As shown below, the [STORAGE] button in the MENU control zone is the function key for the storage system.



Figure 2-21 Function key for the sampling system (storage)

Press the [STORAGE] button to display the storage setup menu. You can use this menu to save waveforms or setup status of the oscilloscope in the internal memory or the USB device, and recall any stored waveform through RefA (or RefB), or press [STORAGE] to recall the setup status. When the USB device is inserted, you can store the oscilloscope's waveform display in bitmap format on the USB device under the UTD2000L directory. The bitmap can be read in a PC.

Operation steps :

Press [STORAGE] to go to the type menu. There are three types to choose from : waveform, setup and bitmap.

1. Select waveform to go to the waveform storage menu shown below (see Figure 2-16). A stored waveform can be recalled with the call back function under waveform storage.

UTD2000L User Manual

Table 2-14 Waveform storage menu (page 1)

Function Menu	Setup	Explanatory Note
Type	Wave	Select the waveform storage and recall menu
Source	CH1 CH2	Selected signal is from CH1 Selected signal is from CH2
Dest	1~20 1~200	Turn the multifunction control knob to set the waveform storage position on the internal memory Set the waveform storage position on the USB device (This function can be enabled only when the USB device is plugged in and the disk menu is set to "USB")
Save	—	Store the waveform
Next page 1/2	—	Go to the next page

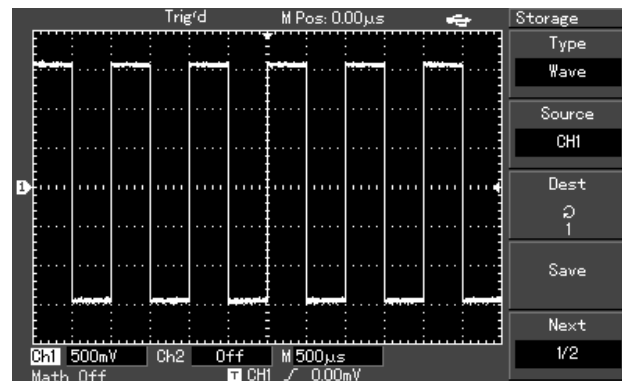

Figure 2-22 Storing the waveform

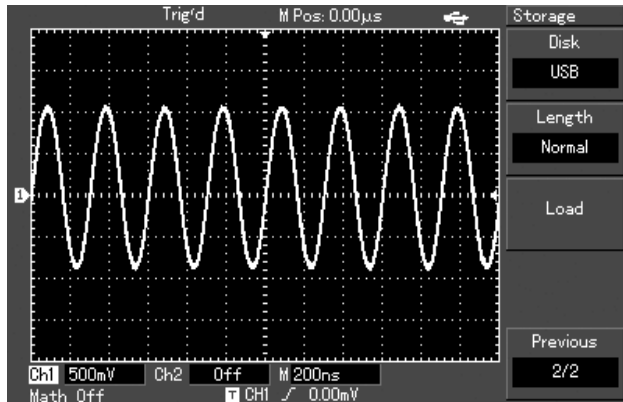

Figure 2-23 Storing a waveform on the USB

Table 2-15 Waveform storage menu (page 2)

Function Menu	Setup	Explanatory Note
Disk	DSO	Select the internal memory of the oscilloscope
	USB	Select the external USB. (This function can only be used with the USB key plugged in)
Lenght	Normal	Select normal storage depth
	Long	Select long storage depth (Note : this function can only be activated when the USB device is plugged in. Data stored in a USB key can only recalled with the waveform loading function of the UTD2000L Series computer test and control software)
Load	—	Recall the waveform
Previous 2/2	—	Return to the previous page

UTD2000L User Manual

- For the setup storage menu, see Table 2-16.

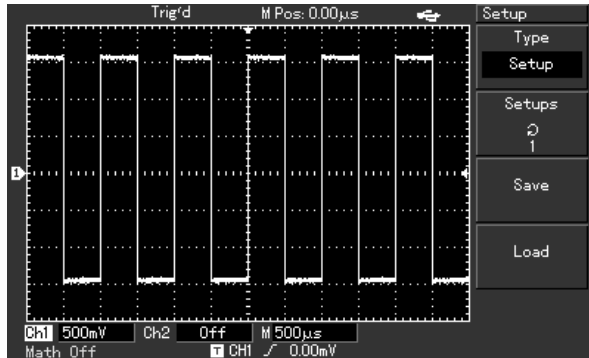

Figure 2-24 Storage setup

Table 2-16 Setting the storage menu

Function Menu	Setup	Explanatory Note
Setup		Select the front panel setup menu
Setups	1~20 1~200	Maximum 20 front panel setups can be stored with the multifunction control knob on the front panel Set the waveform storage position on the USB device (This function can be enabled only when the USB device is plugged in and the disk menu is set to "USB")
Save		Store the setting
Recall		Recall the setting
—		

3. Select bitmap to enter the bitmap storage menu. See Table 2-17.

Note : This function can be enabled only when the USB device is plugged in.

Table 2-17 Bitmap storage menu

Function Menu	Setup	Explanatory Note
Bitmap		Select the bitmap menu
—		
Dest	1~200	Maximum 200 bitmap data can be stored. Select with the multifunction control knob at the top of the front panel (data can only be stored on the USB device)
Save		Store the bitmap data
—		

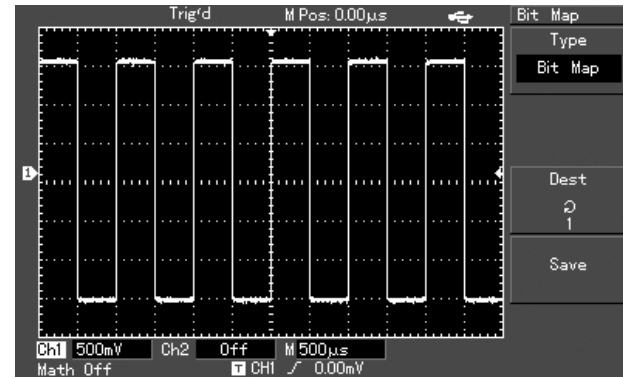

Figure 2-25 Bitmap storing

Utility Function Setup

As shown below, the [UTILITY] button in the MENU control zone is the function key for utility functions.

UTD2000L User Manual



Figure 2-26 Function key for the sampling system (function)

Press the [UTILITY] button to pop out the setup menu for utility functions.

Table 2-18 Utility function menu (page 1)

Function Menu	Setup	Explanatory Note
Selt Adj	Execute Cose	Run auto calibration Cancel auto calibration and return to the previous page
—		
Recorder	See Table 2-21	Setup for recording the waveform
Language	Simplified Chinese Traditional Chinese English Spanish Portuguese French	Select the language interface
—		
Next page 1/3	—	Go to the next page

Table 2-19 Utility function menu (page 2)

Function Menu	Setup	Explanatory Note
Reset		Setting the factory setup recall
—		
Skin	1 2 3 4	Setting the interface designs. Two designs (mono display) / four designs (colour)
Grid Bright	1%-100%	Store the setting
	—	

Table 2-20 Utility function menu (page 3)

Function Menu	Setup	Explanatory Note
Version		Display the current system information of the oscilloscope
—	—	
—	—	
Cymometer	ON OFF	Frequency counter is on Frequency counter is off
First page 3/3	—	Return to the first page

Table 2-21 Waveform record menu (1)
(Press [UTILITY] to enter)

Function Menu	Setup	Explanatory Note
Source	Ch1	Select CH1 as the recording signal source
	Ch2	Select CH2 as the recording signal source
	CH1+CH2	Select CH1 + CH2 as the recording signal source
Operation		Enter the next page for the recording operation menu (as shown in Table 2-22)
Save	1~30	Select the save position for USB waveform recording
Load	1~30	Select the recall position of the USB waveform
Return	—	Return to the first page

Table 2-22 Waveform record menu (2)
(Press [OPERATION] to enter. See the above table)

Function Menu	Setup	Explanatory Note
Record(F1)	—	Record button. Press this button to record. The number of screens recorded is displayed at the bottom of the screen.
Replay(F2)	—	<ol style="list-style-type: none"> 1. Playback button. 2. When you press this button the system plays back. (The number of the screen being played is displayed in the bottom right corner. By turning the multifunction control knob on the upper front panel, you can suspend playback. Turn the knob further and you can select the waveform of a certain screen to be played back repeatedly.) 3. If you wish to continue full playback, press F3 to stop and then press F2. 4. You can record as many as 1,000 screen data.
Stop(F3)		Stop recording
Return(F4)		Return to the previous page

UTD2000L User Manual

Important Points :

Auto Calibration :

You can correct measurement errors caused by environmental changes with the auto calibration function. This process can be run selectively when necessary. To make calibration more accurate, power on your oscilloscope and allow 20 minutes to warm up. Then press the [UTILITY] button (help function) and follow on-screen instructions.

Choose your language :

Your UTD2000L Series Digital Storage Oscilloscope can be operated in many languages .

To select a display language, press the [UTILITY] menu button and choose your desired language.

Automatic Measurement

As shown below, the [MEASURE] button is the function key for auto measurement. Read the following instructions to familiarize with all the powerful automatic measurement functions of your UTD2000L Series Oscilloscope .



Figure 2-27 Function key for the sampling system (auto measurement)

Application Examples

The measurement menu of your oscilloscope is capable of measuring 28 waveform parameters.

Press [MEASURE] to enter the parameter measurement display menu which has 5 zones for simultaneous display of measurement values, assigned to function keys [F1] ~ [F5] respectively. When selecting the measurement type of any zone, press the corresponding function key to enter the type option menu.

The measurement type option menu lets you choose voltage or time. You can enter the voltage or time measurement by pressing [F1] ~ [F5] for the corresponding type, and then return to the parameter measurement display menu. You can also press [F5] and select “ALL PARAMETERS” to show all measurement parameters of both voltage and time. Press [F2] to select the channel (measurement is carried out only when the channel is enabled). If you do not wish to change the current measurement type, press [F1] to return to the parameter measurement display menu.

Example 1 : To display the measurement peak-to-peak value of CH2 in the [F1] zone, follow the steps below :

1. Press [F1] to enter the measurement type option menu.
2. Press [F2] to select channel 2.
3. Press [F3] to select voltage.
4. Press [F5] (1/4 next page) and you will see the peak-to-peak value at position [F3].
5. Press [F3] to select peak-to-peak value and then automatically return to the parameter measurement display menu.

On the first page of the measurement menu, peak-to-peak value is displayed in zone [F1].

Example 2 : Setup for delayed measurement. You can use the delayed measurement function to measure the time interval between the rising edge of two signal source, i.e. the time interval between the rising edge of the first cycle of a certain signal source and the rising edge of the first cycle of another signal source. Measure as follows :

1. In the measurement menu, as shown in the previous example, select the display zone for delayed measurement value (time type page 3/3).
2. Press [F2] to enter the delay menu.
3. Select reference signal source : CH1, and then select the delay signal source : Ch2.
4. Press [F5] to confirm. The delayed measurement is now displayed in your specified zone.

UTD2000L User Manual

Automatic measurement of voltage parameters

Your UTD2000L Series Oscilloscope can automatically measure the following voltage parameters :

Peak-to-peak value (Vpp) : The voltage value from the highest point to lowest point of the waveform.

Maximum value (Vmax) : The voltage value from the highest point to ground (GND) of the waveform.

Minimum value (Vmin) : The voltage value from the lowest point to ground (GND) of the waveform.

Amplitude value (Vamp) : The voltage value from top to base of the waveform.

Mean (Vmid) : Half of the amplitude.

Top value (Vtop) : The voltage value from the level top to ground (GND) of the waveform.

Base value (Vbase) : The voltage value from the level base to ground (GND) of the waveform.

Overshoot : The ratio value of the difference between maximum value and top value to the amplitude value of the waveform.

Preshoot : The ratio value of the difference between minimum value and base value to the amplitude value of the waveform.

Average value : Average amplitude of signals within 1 cycle.

Root mean square value (Vrms) : The effective value. Energy generated by AC signal conversion during 1 cycle with respect to the DC voltage that produces equivalent energy, i.e. root mean square value.

Automatic measurement of time parameters

Your UTD2000L Series Oscilloscope can automatically measure the frequency, cycle, rising time, falling time, positive pulse width, negative pulse width, delay 1→2(rising edge), delay 1→2(falling edge), positive duty ratio, negative duty ratio and 10 time parameters. Definitions of these parameters are as follows :

RiseTime : The time taken by the waveform amplitude to rise from 10% to 90%.

FallTime : The time taken by the waveform amplitude to fall from 90% to 10%.

Positive Pluse Width (+Width) : The pulse width when positive pulse is at 50% amplitude.

Negative Pluse Width (-Width) : The pulse width when negative pulse is at 50% amplitude.

Delay 1→2 (Rising edge) : Delayed time of the rising edge of CH1, Ch2.

Delay 1→2 (Falling edge) : Delayed time of the falling edge of Ch1, Ch2.

Positive duty ratio (+Duty) : Ratio of positive pulse width to cycle.

Negative duty ratio (-Duty) : Ratio of negative pulse width to cycle.

Measurement menu

Operation :

Press [MEASURE] to display the zones for 5 measurement values. You can press any one of F1~F5 to enter the measurement option menu, as shown in Table 2-23.

Table 2-23

Function Menu	Setup	Explanatory Note
Back		Return to the parameter measurement display menu
Source	Ch1	Select the channel for parameter measurement
	Ch2	Select the channel for parameter measurement
Volt		Enter the voltage type parameter menu
Time		Enter the time type parameter menu
Parameters		Display/close all measurement parameters

Voltage type menus are shown in Table 2-24 to Table 2-27.

Table 2-21 Waveform record menu (1) (Press [UTILITY] to enter)

Function/Measurement	Explanatory Note
Previous	Return to the menu shown in Table 2-23
Preshoot	Select to return to the parameter measurement display menu and replace the original parameter in that position
Amplitude	Ditto
Overshoot	Ditto
Next page (1/4)	Turn page

UTD2000L User Manual

Table 2-25

Function/Measurement	Explanatory Note
Previous	Return to the previous page
Mean	Select to return to the parameter measurement display menu and replace the original parameter in that position
Pk-Pk	Ditto
RMS	Ditto
Next (2/4)	Turn page

Table 2-26

Function/Measurement	Explanatory Note
Previous	Return to the previous page
High	Select to return to the parameter measurement display menu and replace the original parameter in that position
Low	Ditto
Middle	Ditto
Next (3/4)	Turn page

Table 2-27

Function/Measurement	Explanatory Note
Previous	Return to the previous page
Max	Select to return to the parameter measurement display menu and replace the original parameter in that position
Min	Ditto
—	
Next (4/4)	Return to page 1 (as shown in Table 2-24)

“Time Type” menus are shown in Table 2-28 to Table 2-31 .

Table 2-28

Function/Measurement	Explanatory Note
Back	Return to the previous page
Freq	Select to return to the parameter measurement display menu and replace the original parameter in that position
Period	Ditto
Rise	Ditto
Next (1/3)	Turn page

Table 2-29

Function/Measurement	Explanatory Note
Previous	Return to the previous page
Fall	Select to return to the parameter measurement display menu and replace the original parameter in that position
+ Width	Ditto
- Width	Ditto
Next (2/3)	Turn page

Table 2-30

Function/Measurement	Explanatory Note
Previous	Return to the previous page
Delay	Select to enter the delay option menu (as shown in Table 2-31)
+Duty	Select to return to the parameter measurement display menu and replace the original parameter in that position
- Duty	Ditto
Next (3/3)	Return to page 1 (as shown in Table 2-28)

Table 2-31

Function Menu	Setup	Explanatory Note
From(Channel)	CH1/CH2/MATH	Select the reference channel
To(Channel)	CH1/CH2/MATH	Select the channel to be measured
—		
—		
OK		Select to return to the parameter measurement display menu and replace the original parameter in that position

Cursor Measurement

Press [CURSOR] to display the measurement cursor and cursor menu, then adjust the cursor position by turning the multifunction control knob. As shown in the figure below, [CURSOR] in the MENU control zone is the function key for cursor measurement.



Figure 2-28 Function key for the sampling system (cursor)

UTD2000L User Manual

You can move the cursor to carry out measurement in the [CURSOR] mode. There are three modes to choose from : voltage, time and tracking. When measuring voltage, press [PUSH SELECTED] and [F2] on the front panel. Positions of the two cursors and the cursor moving speed can be adjusted with the multifunction control knob to measure V. Likewise, by selecting time, you can measure t. In the tracking mode and waveform display is on, you can see the cursor and track signal changes automatically by adjusting with the multifunction control knob.

Notes :

1. [PUSH SELECTED]: To select the cursor.
2. Coarse tune/fine tune : To adjust the cursor moving speed.
3. Measuring voltage/time : Cursor 1 or cursor 2 will appear simultaneously. Adjust their positions on the screen with the multifunction control knob and select which cursor to adjust with the [PUSH SELECTED] button. The displayed reading is the voltage or time value between the two cursors.
4. Tracking mode : Horizontal and vertical cursors cross to form a cross-shaped cursor. It automatically positions itself on the waveform. You can adjust the horizontal position of the cross cursor by turning the multifunction control knob. Your oscilloscope will also display the coordinate of the cursor point.

5. When the cursor function is enabled, measurement value is automatically displayed in the upper right hand corner.

Using the Run Button

There is a button on the top right hand corner on the front panel : [RUN/STOP]. When this button is pressed and a green indicator lights up, your oscilloscope is in a running status. If a red light comes on after pressing this button, it indicates the unit has stopped operation.



Figure 2-29 RUN/STOP button

Auto Setup :

As shown above, auto setup can simplify operation. Press [AUTO] and the oscilloscope can automatically adjust the vertical deflection factor and horizontal time base range according to the amplitude and frequency of the waveform, and ensure stable display of the waveform. When the oscilloscope is in auto setup mode, the system setup is as follows :

Table 2-32

Function Menu	Setup
Acquisition mode	Sampling
Display format	Set to YT
Horizontal position	Automatic adjustment
SEC/DIV	Adjust according to signal frequency
Trigger coupling	AC
Holdoff	Minimum value
Trigger level	Set at 50%
Trigger mode	Auto
Trigger source	Set to CH1 but if there is no signal in CH1 and CH2 applies a signal, it will set to CH2
Trigger inclination	Rising
Trigger type	Edge
Vertical bandwidth	Full
VOLT/DIV	Adjust according to amplitude of the signal

RUN/STOP : Acquire waveform continuously or stop acquisition.

If you want the oscilloscope to acquire waveform continuously, press [RUN/STOP] once. Press the button again to stop acquisition. You can use this button to switch between acquiring and stop acquiring waveform. In the Run mode, a green light comes on and AUTO appears on the screen. In the STOP mode, a red light comes on and STOP appears on the screen.

Chapter 3 Practical Example Illustrations

Illustration 1 : Measuring simple signals

To observe and measure an unknown circuit signal, and to quickly display and measure the signal 's frequency and peak-to-peak value.

1. To quickly display this signal, follow the steps below :

- ① In the probe menu, set the attenuation factor to 10X and set the switch on the probe to 10X.
- ② Connect the CH1 probe to the circuitry point to be measured. Press [AUTO].
- ③ The oscilloscope will carry out auto setup to optimise waveform display. In this status, you can further adjust the vertical and horizontal range until you get the desired waveform display.

2. Voltage and time parameters for automatic measurement

Your oscilloscope can automatically measure most display signals. To measure signal frequency and peak-to-peak value, follow the steps below :

- ① Press [MEASURE] to display the automatic measurement

menu.

- ② Press [F1] to enter the measurement type selection menu.
- ③ Press [F3] to select voltage.
- ④ Press [F5] to go to page 2/4, then press [F3] to select measurement type : peak-to-peak value.
- ⑤ Press [F2] to enter the measurement type selection menu, then press [F4] to select time.
- ⑥ Press [F2] to select measurement type : frequency. Peak-to-peak value and frequency measurement value are now displayed in positions [F1] and [F2] respectively.

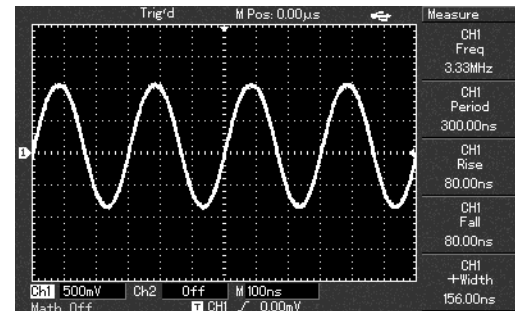

Figure 3-1 Automatic measurement

Illustration 2 : Observing the delay caused by a sine wave signal passes through the circuit

As in the previous scenario, set the probe attenuation factor of the probe and oscilloscope channel to 10X. Connect the CH1 to the circuit signal input terminal. Connect CH2 to the output terminal.

Steps :

1. To display CH1 and CH2 signals :
 - ① Press [AUTO].
 - ② Continue to adjust the horizontal and vertical range until you get the desired waveform display.
 - ③ Press [CH1] to select CH1. Adjust vertical position of the CH1 waveform by turning the vertical position control knob.
 - ④ Press [CH2] to select CH2. In the same way described above, adjust vertical position of the CH2 waveform so that the waveforms of CH1 and CH2 do not overlap. This will make observation easier.
2. Observing the delay caused by a sine wave signal passes through the circuit and observing waveform changes.
 - ① When measuring channel delay automatically :
Press [MEASURE] to display the automatic measurement

menu.

Press [F1] to enter the measurement type selection menu.

Press [F4] to enter the time measurement parameters table.

Press [F5] twice to go to page 3/3.

Press [F2] to select delayed measurement.

Press [F1], select CH1 and then press [F2] to select moving to CH2, then press [F5] to confirm.

You can see the delay value below “CH1-CH2 delay” in the [F1] zone now.

- ② Observe waveform changes (see the figure below).

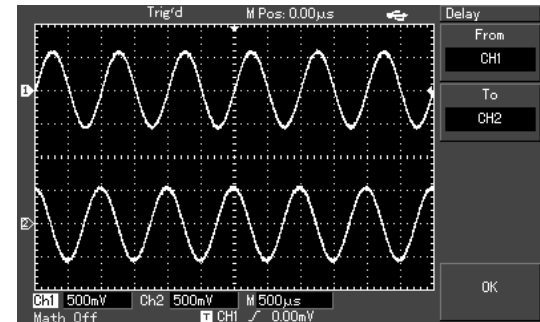

Figure 3-2 Waveform delay

UTD2000L User Manual

Illustration 3 : Acquiring single signals

The advantage and special feature of your digital storage Oscilloscope lie in its ability to acquire non cyclical signals like pulse and glitch. To acquire a single signal, you must have transcendental knowledge of that signal to set the trigger level and trigger edge. For example, if the pulse is a logical signal of TTL level, the trigger level should be set at about 2V and the trigger edge should be set to rising edge trigger. If you are not certain about the signal, you can observe it by automatic or normal trigger to determine the trigger level and trigger edge.

Steps :

1. As in the previous illustration, set the attenuation factor of the probe and Ch1.
2. Carry out trigger setup.
 - ① Press [TRIG MENU] in the trigger control zone to display the trigger setup menu.
 - ② In this menu, use F1~F5 menus to set the trigger type to EDGE, set trigger source to CH1, set inclination to RISING, set trigger type to SINGLE and set trigger coupling to AC.
 - ③ Adjust horizontal time base and vertical range to an appropriate range.
 - ④ Turn the [TRIGGER LEVEL] control knob to get the desired level.
 - ⑤ Press [RUN/STOP] and wait for a signal that meets the trigger condition. If any signal reaches the set trigger level, the system will sample once and display it on the screen. By using this function you can easily acquire any occasional event. For example, when a sudden glitch of relatively big amplitude is acquired : set the trigger level to just higher than the normal signal level. Press [RUN/STOP] and begin waiting. When a glitch occurs, the machine will automatically trigger and record the waveform immediately before and after triggering. By turning the horizontal POSITION knob in the horizontal control zone on the front panel, you can change the trigger position horizontally to achieve negative delay trigger of various lengths for easy observation of waveform occurring before the glitch

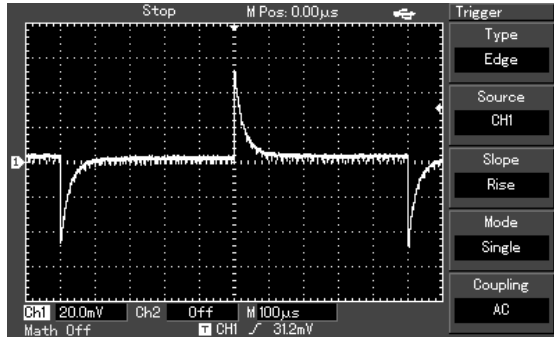

Figure 3-3 Single signal

Illustration 4 : Reducing random noise of signals

If the signal being measured is stacked with random noise, you can adjust the setups of your oscilloscope to filter or reduce the noise, so it will not cause interference to the signal during measurement. (Waveform is shown below)

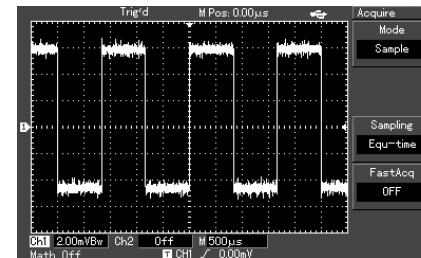

Figure 3-4 Reducing random noise of signals

Steps:

1. As in the previous illustration, set the attenuation factor of the probe and Ch1.
2. Connect the signal to ensure stable display of waveform. See the previous illustration for operation instruction. See the previous chapter for guidance on adjusting the horizontal time base and vertical range.

UTD2000L User Manual

3. Improving trigger by setting trigger coupling .
 - ① Press [TRIG MENU] in the trigger zone to display the trigger setup menu.
 - ② Set TRIGGER COUPLING to LOW FREQUENCY SUPPRESSION or HIGH FREQUENCY SUPPRESSION . By selecting low frequency suppression a high-pass filter is set up . It filters low frequency signal quantities under 80kHz and allows high frequency signal quantities to pass through . If you select high frequency suppression a low-pass filter is set up . It filters high frequency signal quantities higher than 80kHz and allows low frequency signal quantities to pass through . By setting LOW FREQUENCY SUPPRESSION or HIGH FREQUENCY SUPPRESSION , you can suppress low frequency or high frequency noise respectively and achieve a stable trigger.
4. Reducing display noise by setting the sampling mode.
 - ① If the signal being measured is stacked with random noise and the waveform is too coarse as a result, you can use the average sampling mode to eliminate random noise display and reduce the size of waveform for easy observation and measurement. After getting the mean, random noise is

reduced and details of the signal are clearer. Follow the steps below :

Press [ACQUIRE] in the menu zone of the front panel to display the sampling setup menu. Press menu operation key [F1] to set acquisition mode to AVERAGE, then press the multifunction control knob to adjust the average number of times in multiples of 2, i.e. 2 to 256 , until you get the desired waveform display that meets observation and measurement requirements . (See the figure below)

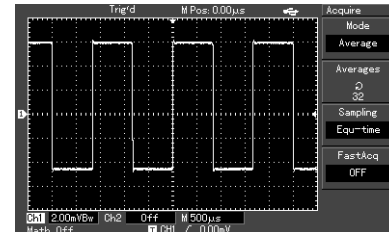

Figure 3-5 Signal noise suppressed

- ② You can also lower the waveform brightness to reduce display noise.

Caution :In the average sampling mode the waveform display will update at a slower rate. This is normal.

Illustration 5: Using the cursors for measurement

Your oscilloscope can measure 28 waveform parameters automatically. All auto parameters can be measured with the cursors. By using the cursors, you can quickly measure the time and voltage of a waveform.

Measuring one step voltage of the step signal

To measure one step voltage of the step signal, follow the steps below :

1. Press [CURSOR] to display the cursor measurement menu.
2. Press menu operation key [F1] to set cursor type to VOLTAGE.
3. Turn the multifunction control knob to set cursor 1 at one step voltage of the step signal.
4. Press [PUSH SELECTED] to select the cursor, then turn the multifunction control knob again to set cursor 2 at another step voltage of the step signal.

The cursor menu will automatically display the V value, i.e. the voltage difference of that point. See the figure below.

Note : When using the cursors to measure time, follow step 2 only and set the cursor type to time.

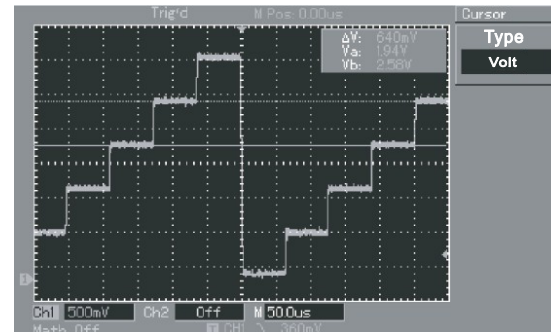

Figure 3-6 : Using the cursors to test signal voltage

Illustration 6 : Using the X-Y function

To check the phase difference between two channels.

Example : To measure the phase variation when a signal passes through the circuit, connect your oscilloscope to the circuit and monitor the input and output signals. To check the circuit's input and output in the X-Y coordinate mode, follow the steps below :

1. Set the attenuation factor of the probe to 10X. Set the switch of the probe to 10X.
2. Connect the CH1 probe to the input terminal of the network. Connect the CH2 probe to the output terminal of the network.
3. If the channel is not displayed, press the [CH1] and [CH2] menu button to enable the two channels.
4. Press [AUTO].
5. Adjust the vertical scale knob to make the displayed amplitude of the two channels to about equal.
6. Press the [DISPLAY] menu key to recall the display menu.
7. Press F2 to select X-Y. The oscilloscope will display the circuit's input and output characteristics in a Lissajous figure.
8. Adjust the vertical scale and vertical position knob to achieve the best result of waveform.
9. Using the elliptical oscilloscope display graph to observe, measure

and calculate the phase difference. (see the figure below)

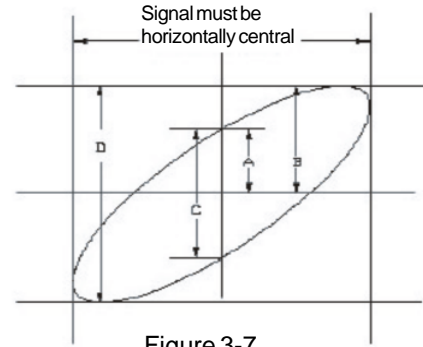

Figure 3-7

$$\text{If } \sin\theta = \frac{A}{B} \text{ or } \frac{C}{D} ,$$

θ is the angle of disparity between the channels. For definitions of A, B, C, D see the above figure. Calculating with this formula, the angle of disparity is

$$\theta = \pm \arcsin\left(\frac{A}{B}\right) \text{ or } \theta = \pm \arcsin\left(\frac{C}{D}\right)$$

If the elliptic main axis is within quadrants I and III, the angle of disparity should be within quadrants I and IV, i.e. inside $(0 \sim \frac{\pi}{2})$ or $(\frac{3\pi}{2} \sim 2\pi)$.

If the main axis is within quadrants II and IV, the angle of disparity should be within quadrants II and III, i.e. inside $(\frac{\pi}{2} \sim \pi)$ or $(\pi \sim \frac{3\pi}{2})$.

Furthermore, if the frequencies and phase differences of two signals being measured are whole multiples, you can calculate the frequency and phase correlation between the two signals.

10. X-Y Phase difference table :

X-Y Frequency ratio	Phase					
	0°	45°	90°	180°	270°	360°
1:1						
1:2						
1:3						
1:4						

Illustration 7 : Using the USB upgrade program

The USB upgrade program makes upgrade easier and more flexible. To use this function follow the steps below :

1. Check the model name, software and hardware versions of your oscilloscope in Table 2-19.
2. Download the highest version of the update program document that matches your model, software and hardware versions online, and store it on the USB device (preferably a USB device recommended by us).
3. Power off the oscilloscope then insert the USB device. Then power on the oscilloscope again. The prompt “Please press [F5] to continue or [F1] to cancel” appears on the screen, as shown in the figure on the right.

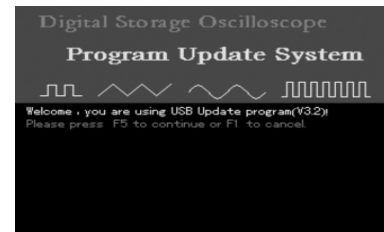

Figure 3-8 USB update confirmation

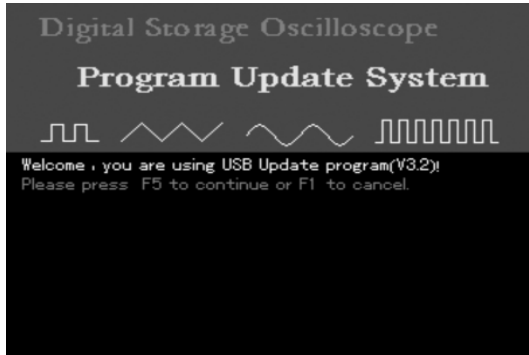

Figure 3-8 USB update confirmation

After pressing F5, the screen will prompt you to select the update program, as shown in the following figure. You can now select the required update program with the multifunction control knob then press [F5] to move to the next step (If there is only one program on the USB device, the following screen will not appear. The system will move straight to the next step).

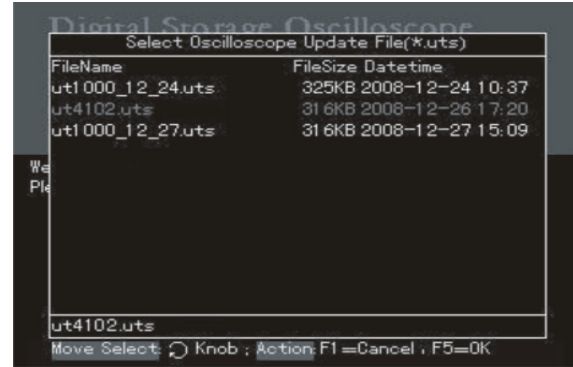

Figure 3-9 Selection of the USB upgrade document

- When [F5] is pressed as shown in Figure 3-9, the prompt on the right will appear: "Are you sure you wish to update? If yes, press [F5], otherwise press [F1] to cancel upgrade".

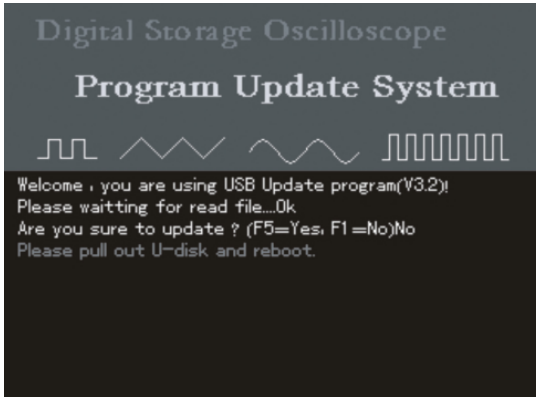

Figure 3-10 Confirming the USB update document

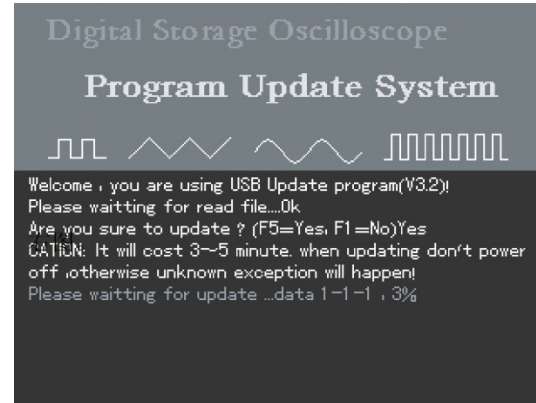

Figure 3-11 USB upgrade in progress

- When the USB document is confirmed the following prompt will appear : “System upgrade is in progress. Please wait” . (This process may take 3 to 5 minutes)
- When update is complete, a successful update prompt will appear : “Upgrade is successfully complete. Please remove USB device, then power off your oscilloscope and power it back on again to complete the process.” The oscilloscope program is now updated and system upgrade is complete. In the event of update failure, follow the steps below.

Caution : If upgrade fails due to power interruption, power off the oscilloscope and repeat all the USB update steps.

Below are some common causes for update failure :

1. No update document.

If there is no document with the suffix “uts” , the following message will appear when [F5] is pressed after powering on :

“Can't find the valid update file! Please ensure there is update file on the USB device then restart the operation.” ●

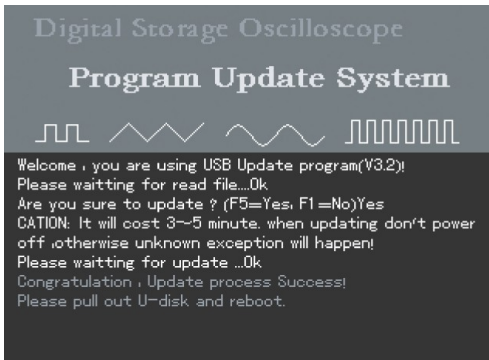

Figure 3-12 Successful USB update

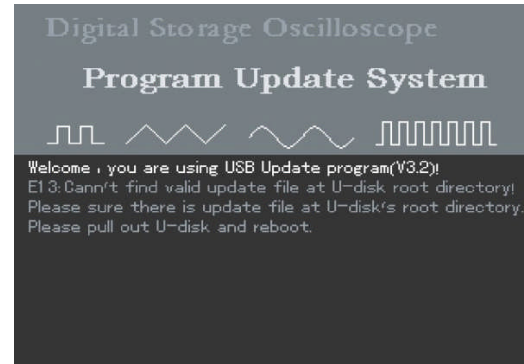

Figure 3-13 No valid update document

2. The user cancels the update process.

- ① When the oscilloscope is restarted with the USB device plugged in, you can cancel upgrade by pressing [F1]. To cancel upgrade and operate your oscilloscope normally, follow the on-screen instructions : “Remove the USB device and reboot.”

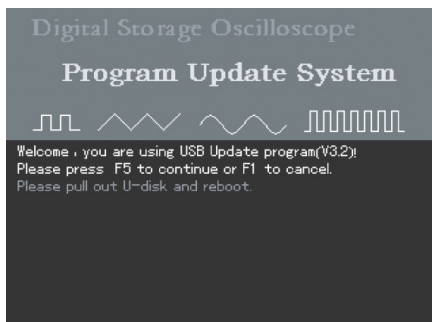

Figure 3-14 Cancel update (1)

- ② During the update process, you can cancel update by pressing [F1]. To cancel upgrade and operate your oscilloscope normally, follow the on-screen instructions : “Remove the USB device and reboot.”

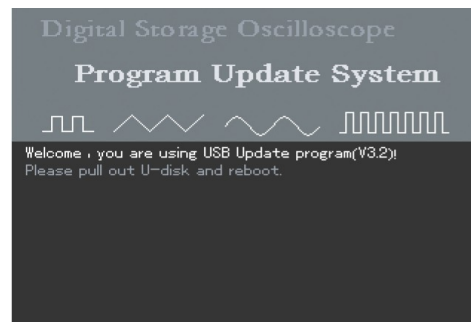

Figure 3-15 Cancel update (2)

UTD2000L User Manual

- ③ You can still cancel update when the oscilloscope is ready for the process. Simply press [F1] to return to normal operation. Please follow the on-screen instructions :
“Remove the USB device and reboot.”
- 3. The USB device is removed before update begins
If the USB device is removed when the update document is being read before commencement of update, the following prompt will appear : “USB device has been removed! Please reboot.” To resume normal operation, power on the oscilloscope with the USB device unplugged.

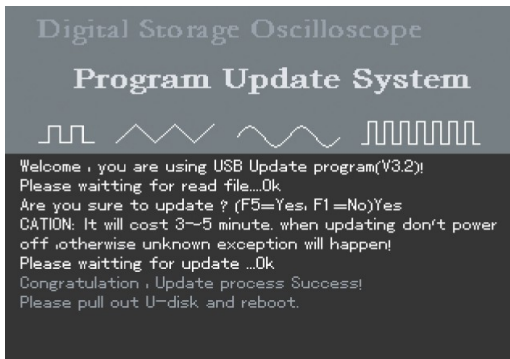

Figure 3-16 Cancel upgrade (3)

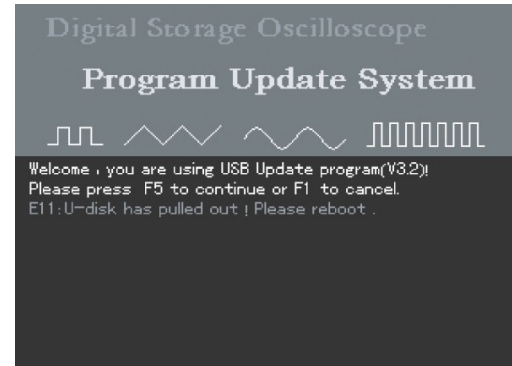

Figure 3-17 USB device is removed before update

4. Incorrect update document

If the version of the update document on the USB device is incorrect, update will fail upon selecting the upgrade document by pressing [F5] (Figure 3-18). You will see the prompt : “Incorrect upgrade document” . Save a correct document on the USB device and repeat the previous steps for upgrade.”

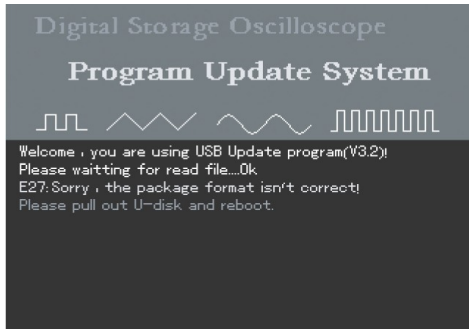

Figure 3-18 Incorrect update document version

5. Failure in reading update document

After selecting the update document, press [F5] to read. If the document cannot be read, you will see the prompt : “Sorry, upgrade has failed. Please contact our after-sales service department” . It may be that our oscilloscope does not support your USB device, or document reading is unsuccessful due to other reasons. You can retry and see if the problem can be solved, or use a USB device we recommend. If the problem persists, contact our after-sales service department. To resume normal operation, power off your oscilloscope and then reboot.

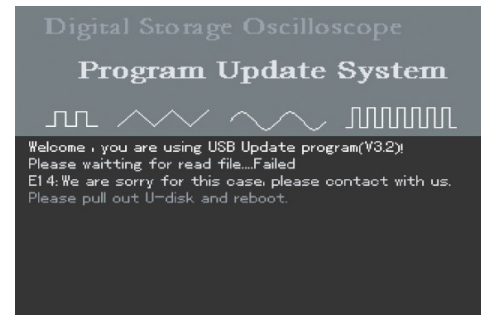

Figure 3-19 Reading failure

UTD2000L User Manual

6. Low software version

If the version of USB document is lower than that of the oscilloscope, update will fail. You will be prompted that, “Software version too low. Please read the user manual for further instructions.” This indicates that the software version you have saved on to the USB device is lower than the existing one on the oscilloscope. You should acquire the correct version either online or through our after-sales service department. To see version information, press [UTILITY] [SYSTEM CONFIGURATION] [SYSTEM INFORMATION]. Please download the suitable update document.

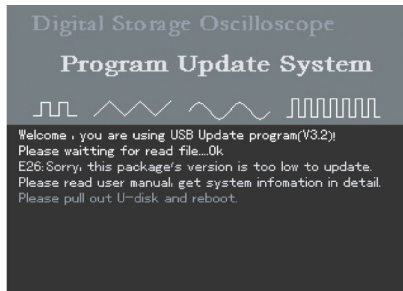

Figure 3-20 Low software version

7. Software document incompatible with product model

If the USB update document is incompatible with the oscilloscope model, update will fail. You will be prompted that, “Software and product model incompatible. Please read the user manual for further instructions.” You should download an update document which corresponds with your oscilloscope model, e.g. UTD2102CEL, then repeat the USB update steps.

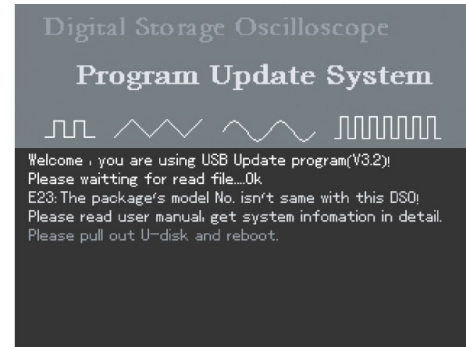

Figure 3-21 Incompatible software document and product model

Illustration 8 : Screen copy

You can press the screen copy key (PrtSc) to intercept a full screen. To use this function, follow the steps below :

1. Press the screen copy key (PrtSc), copying is done when the completion screen is displayed.
2. Store the intercepted graphic on the USB device. Insert the USB device, press [STORAGE] and select bitmap in the type menu. Select any storage position between 1 and 200 with the multifunction control knob, then press F4 (storage key) to complete the storage process.

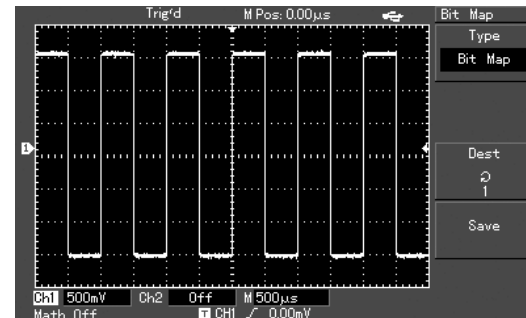

Figure 3-22 Copying a screen on to the USB device

Note : When the USB device is plugged into DSO, the graphic will be stored on the USB directly.

Chapter 4 System Prompts and Trouble-shooting

Definitions of System Prompts

Adjustment at Ultimate Limit : This informs you that the multifunction control knob has reached its adjustment limit in the current status. No further adjust is possible. When the vertical deflection factor switch, time base switch, X shift, vertical shift and trigger level adjustments have reached their ultimate limits, this prompt will appear.

USB Device Installed : After a USB device is plugged into the oscilloscope, this prompt appears when the connection is valid.

USB Device Unplugged : After a USB key is unplugged from the oscilloscope, this prompt appears.

Saving : When the oscilloscope is saving a waveform, this prompt is shown on the screen. A progress bar appears at the bottom.

Loading : During waveform recall, this prompt is shown on the screen. A progress bar appears at the bottom.

Troubleshooting

1. If the screen of your oscilloscope remains black without any display after powering on, follow the steps below to find the cause :
 - ① Check the power cable connection and check if there is normal power supply.
 - ② Check if the power switch is properly pressed.
 - ③ Restart the unit after performing the above checks.
 - ④ If the unit still fails to work, contact UNI-T to request service.
2. If no waveform is displayed after you have acquired a signal, follow the steps below to find the cause :
 - ① Check whether the probe is properly connected to the signal lead.
 - ② Check whether the signal lead is properly connected to the BNC (channel adaptor).
 - ③ Check whether the probe is connected properly to the object to be measured.
 - ④ Check whether the object for measurement is generating signals (connect the channel with signals to the questionable channel to find the cause).
 - ⑤ Restart the acquisition process.

3. The measurement voltage amplitude value is 10 times larger or smaller than the actual value :
Check if the channel attenuation factor corresponds with the probe attenuation you have chosen .
4. There is waveform display but it is not stable :
 - ① Check the TRIGGER SOURCE setup in the trigger menu. See whether it is the same as the actual signal input channel.
 - ② Check the trigger type : Use EDGE TRIGGER for ordinary signals and VIDEO TRIGGER for video signals. Stable waveform display is achieved only when the correct trigger mode is selected.
 - ③ Try changing the COUPLING display to HIGH FREQUENCY SUPPRESSION or LOW FREQUENCY SUPPRESSION to filter any high or low frequency noise that is interfering with triggering.
5. No display after pressing [RUN/STOP] :
 - ① Check if the TRIGGER MODE is set to NORMAL or SINGLE in the menu, and whether the level exceeds the waveform range.
If so, move the trigger level to the centre or set TRIGGER MODE to AUTO.
 - ② Press [AUTO] to complete the automatic setup.
6. Display speed is slow after average sampling time is enabled :
 - ① If average sampling is carried out for more than 32 times, the display speed will drop. This is normal.
 - ② You can reduce the intervals of average sampling.
7. Trapezoidal waveform display :
 - ① This is normal. The reason is possibly horizontal time base range is too low. You can improve horizontal pixel aspect ratio and enhance the display quality by increasing the horizontal time base.
 - ② If the display type is VECTOR, the connection between sampling dots may cause a trapezoidal waveform. Set the display type to DOT to solve this problem.

Chapter 5 Service and Support

Warranty (UTD2000L Series Digital Storage Oscilloscope)

UNI-T (Uni-Trend Electronic (Shanghai) Limited) warrants that product produced and marketed by it will be free from defects in materials and workmanship for a period of three years from the date of shipment by the authorized dealer. If any such product proves defective during this warranty period, UNI-T will repair the defective product or provide a replacement according to specific terms and conditions of the warranty.

To request maintenance and repair service or a full copy of the warranty, please contact your nearest UNI-T sales and maintenance office.

Save and except the guarantee given herein or in other applicable warranty, UNI-T makes no other express or implied guarantee, including but not limited to any implied guarantee on the product's tradability and suitability for any specific purpose. Under no circumstance will UNI-T bear any liability for any indirect, special or subsequent loss.

Contact Us

If you encounter any inconvenience in using this product, contact Uni-Trend Electronic (Shanghai) Limited (Uni-T, Inc.) in China directly.

Office hours : 8:00am – 5:30pm Beijing Time Monday to Friday .
Alternatively, email us at infosh@uni-trend.com.cn.

For product support outside China , contact your local UNI-T supplier or sales centre.

Service Support : Many UNI-T products offer optional plans of extended warranty period or calibration period. For details please contact your local UNI-T supplier or sales centre.

A list of service centres worldwide is available online at <http://www.uni-trend.com>

Chapter 6 Appendixes

Appendix A : Technical Indicators

Unless otherwise specified, all technical specifications apply to probes with attenuation setting of 10X and the UTD2000L Series Digital Oscilloscope. To verify that your oscilloscope meets specifications, it must first meet the following conditions :

- The oscilloscope must have been operating continuously for thirty minutes at the specified operating temperature.
- If the operating temperature changes by more than 5° C , you must perform the “Self Cal” operation , accessible through the system functions menu . All specifications are guaranteed unless noted “Typical” .

Technical Indicators

Sampling			
Sampling modes	UTD2102CEL	UTD2052CEL	UTD2052CL
Real time sampling	1GS/s		500MS/s
Equivalent sampling	50GS/s		25GS/s
Bandwidth	100MHz	50MHz	50MHz
Sampling	Sampling, peak detect, average		
Average value	When all channels have made N samplings simultaneously, N is selectable from 2, 4, 8, 16, 32, 64, 128 to 256		

Input	
Input coupling	DC, AC, GND
Input impedance	1MΩ ± 2% in parallel with 20 ± 3pF
Probe attenuation factor	1x, 10x, 100x, 1000x
Maximum input voltage	400V (DC + AC Peak, 1MΩ input impedance)
Time delay between channels (Typical)	150ps

UTD2000L User Manual

Horizontal	
Waveform interpolation	Sin (x) / x
Recording length	2 x 600k sampling dot
Saving depth	25k for single channel; 12.5k for dual channels
Scanning range (s/div)	2ns/div-50s/div (UTD2102CEL, UTD2052CEL, at 1-2-5 increment) ; 5ns/div-50s/div (UTD2052CL, at 1-2-5 increment) .
Accuracy of sampling rate and delay time	± 50ppm (any time interval ≥1ms)
Time interval (ΔT) Measurement accuracy (full bandwidth)	Single : ± (1 sampling time interval + 50ppm x reading + 0.6ns) ; > 16 average values : ± (1sampling time interval + 50ppm x reading + 0.4ns)

Vertical	
A/D converter	8-bit resolution
Deflection factor range (VOLTS/DIV)	1 mV/div ~ 20V/div (at input BNC)
Position range	± 10div
Analog bandwidth	100MHz (UTD2102CEL), 50MHz (UTD2052CL, UTD2052CEL)
Single bandwidth	100MHz (UTD2102CEL), 50MHz (UTD2052CL, UTD2052CEL)
Selectable analog bandwidth limit (Typical)	20MHz
Low frequency response (AC coupling, -3dB)	≤10Hz at BNC
Rise time	3.5ns, 7ns at 100MHz and 50MHz bandwidths respectively
DC gain accuracy	When vertical sensitivity is 1mV/div~2mV/div : ± 5% (sample or average acquisition mode) ; When vertical sensitivity is 5mV/div : ± 4% (sample or average acquisition mode) ; When vertical sensitivity is 10mV/div~50V/div : ± 3% (sample or average acquisition mode)
DC measurement accuracy (average acquisition mode)	When vertical position is zero and $N \geq 16$: ± (5% x reading + 0.1 div + 1mV) and 1mV/div~2mV/div is selected ; ± (4% x reading + 0.1 div + 1mV) and 5mV/div is selected ; ± (3% x reading + 0.1 div + 1mV) and 10mV/div~50V/div is selected ; When vertical position is not zero and $N \geq 16$: ± [3% x (reading + vertical shift reading) + (1% x vertical shift reading)] + 0.2div. Set from 5mV/div to 200mV/div plus 2mV ; Setup value > 200mV/div to 50V/div plus 50mV.
Voltage difference (ΔV) measurement accuracy (average acquisition mode)	Under identical setup and environmental conditions, the voltage difference (ΔV) between any two points of the waveform after the average of ≥ 16 waveforms acquired waveforms is taken : ± (3% x reading + 0.05div)

UTD2000L User Manual

Trigger	
Trigger sensitivity	Internal trigger: 1 div; external trigger : 0.2V
Trigger level range	± 8div from the centre of the screen
Trigger level accuracy (Typical) applied on signals of $\geq 20\text{ns}$ rise or fall time	$\pm (0.3\text{div} \times \text{V/div})$ (within $\pm 4\text{div}$ from the centre of the screen)
Pretrigger capability	Normal mode/scanning mode, pretrigger/delayed trigger. Pretrigger depth is adjustable
Holdoff range	100ns-1.5s
Set level to 50% (Typical)	Input signal frequency $\geq 50\text{Hz}$
Edge Trigger	
Edge type	Rise, fall, rise and fall
Pulse Trigger	
Trigger mode	(Greater than, less than or equal to) positive pulse ; (Greater than, less than or equal to) negative pulse
Pulse width range	20ns-10s
Alternate Trigger	
A Trigger	Edge, pulse
B Trigger	Edge, pulse

Measurement		
Cursor	Manual mode	Voltage difference (ΔV) between cursors; time difference (ΔT) between cursors; time difference (ΔT) countdown (Hz) ($1/\Delta T$)
	Automatic measurement mode	Cursor display is enabled during measurement
Automatic measurement	Peak-to-peak, amplitude, maximum, minimum, top, bottom, mean, average, root mean square, overshoot, preshoot, frequency, cycle, rising time, falling time, positive pulse, negative pulse, positive duty ratio, negative duty ratio, delay.	
Customized parameter measurement	3types	
Math functions	+, -, ×, /	
Saving waveforms	Internal : 20 groups of waveforms and 20 setups USB : 200 groups of screens, 200 groups of waveforms	
FFT	Window	Hanning, Hamming, Blackman-Harris, Rectangular
	Sampling points	1024 points
Lissajous Figure	Phase difference	± 3 degrees

Trigger frequency counter	
Reading pixel aspect ratio	6
Trigger sensitivity	30Vrms
Accuracy (Typical)	± 51 ppm (including all frequency reference errors and ± 1 word)

UTD2000L User Manual

Display	
Display type	178mm diagonal line (7") LCD panel
Display resolution	800 horizontal x RGB x 480 vertical pixels (color)
Display Colour	Colour
Waveform display zone	Lateral 12 div, 25 dot/div Longitudinal 8 div, 25 dot/div
Display contrast (Typical)	Adjustable
Backlight Intensity (Typical)	300nit
Display Languages	Simplified Chinese, Traditional Chinese, English, Spanish, Portuguese, French

Interface Functions	
Standard setup	1 x USB OTG
Optional	

Power Source	
Source Voltage	100-240VAC _{RMS} , 45-440Hz, CAT II
Power Consumption	Less than 30VA
Fuse	F1.6AL250V The UTD2000L series fuse is on the power board inside the unit

Environmental	
Temperature	Operating : 0C~+40C
	Non-operating : -20°C~+60°C
Cooling Method	Natural cooling
Humidity	+10C~+30C : ≤ 95% ± 5% RH ;
	+30C~+40C : ≤ 75% ± 5% RH ;
	+10C~+30C : ≤ 95% ± 5% RH ; +30C~+40C : ≤ 75% ± 5% RH
Altitude	Operating : under 3,000m
	Non-operating : under 15,000m

Mechanical Specifications		
Dimension (reference only)	Width	306mm
	Height	147mm
	Depth	122mm

Weight		
Input coupling	Without packaging	2.2kg
Input impedance	With packaging	3.3kg

IP Protection	IP2X
---------------	------

Adjustment frequency
Recommended calibration frequency is 1 year

Appendix B : Accessories for UTD2000L Series Digital Storage Oscilloscope

Standard Accessories :

- Two 1.5m, 1:1(10:1) passive voltage probes. For details please read the probe manual. EN61010-031:2002 standard.
Rating is 150V CAT II when the switch is in the 1X position ;
Rating is 300V CAT II when the switch is in the 10X position.
- One international standard power cord.
- One User Manual.
- One Product Warranty Card.
- UTD2000L communication & control software.
- USB connection cable : UT-D05.

Appendix C : Maintenance and Cleaning

General Care

Do not store or leave the oscilloscope where the LCD display will be exposed to direct sunlight for long periods of time.

Caution : To avoid damage to the oscilloscope or probes, do not expose them to sprays, liquids or solvents.

Cleaning

Inspect the oscilloscope and probes as often as operating conditions require. To clean the exterior surface, follow these steps :

1. Remove dust on the outside of the oscilloscope and probes with a soft cloth. When cleaning the LCD, use care to avoid scratching the clear protection film of the LCD.
2. Use a dampened but not dripping soft cloth to clean the oscilloscope. Remember to disconnect power. Use a mild cleaner or water. To avoid damaging the product or probe, do not use abrasive chemical cleaner.

Warning : To avoid short circuit or personal injury due to the presence of moisture, please ensure the product is completely dry before reconnecting power for operation.

UTD2000L User Manual

Index

Alphabet

DSO	40
EXT	33
FFT resolution	23
FFT frequency analysis	41
USB	1
X-Y mode	24
Y-T mode	24

Chinese

Negative duty ratio	47
Positive duty ratio	48
Amplitude	47
Mean	47
General check	5
General care	78
Rise time	49
Fall time	47
System prompts	69

Refresh rate	38
Single trigger	34
Cycle	21
Vertical system	9
Grid	28
Acquisition	35
Cursor measurement	50
Display system	37
Compulsory	13
Horizontal system	14
Math	20
Measurement	45
Preshoot	47
Storage	5
RUN/STOP	52
Trigger system	12
Functions	15
Vertical system	15
Select	16

Coarse tune	15	Measuring simple signals	53
Nyquist frequency	22	Sec/div	11
Realtime sampling	37	Pulse width trigger	28
Top value	47	Language selection	45
Bottom value	47	Off	10
Technical indicators	72	Using the RUN button	51
Waveform inversion	21	Horizontal system	10
Waveform recording	44	Factory setup	43
Pulse trigger	75	Functional check	1
Overshoot	47	External trigger	28
Cleaning	78	Average	47
Top value	47	Average acquisition	21
Save	38	Positive pulse width	30
Warranty	71	Power	77
Signal source	21	Edge trigger	27
Bandwidth suppression	17	Alternate trigger	27
Troubleshooting	69	Cursor measurement	50
Window extension	24	Tracking	51
Display system	37	Screen design	44
Display type	77	Input channel	33
Standard accessories	77	Storage and recall	38

UTD2000L User Manual

Trigger coupling	12	Sampling system	35
Mechanical specifications	77	Coarse tune/fine tune	51
Automatic setup	70	Utility system functions	42
Automatic measurement	45	Maximum value	47
Automatic trigger	55	Minimum value	47
Self calibration	45	Equivalent sampling	37
Holdoff	23	Contact us	71
Negative pulse width	30	Math	20
Root mean square value	47	Trigger level	27
Peak measurement	35	Trigger setup	12
Peak-to-peak	46	Trigger system	12
Acquiring single signals	55	Hold off	23
Recall	38		
Range adjustment	19		
Delayed measurement	54		
Channel setup	18		
Channel coupling	16		
Pretrigger	34		
Reducing signal random noise	56		
Probe compensation	8		
Probe rate	18		

This user manual may be revised without prior notice.

UTD2000L User Manual

Copyright 2009 Uni-Trend Group Limited.
All rights reserved.

Manufacturer:
Uni-Trend Technology (chengdu) Limited
2/Floor, Block D2,
199 Xiqu Da Dao,
Gaoxin Xiqu,
Cheng Du City,
Si Chuan Province, China
PostalCode: 611 731

Headquarters:
Uni-Trend Group Limited
Rm901 , 9/F, Nanyang Plaza
57 Hung To Road
Kwun Tong
Kowloon, Hong Kong
Tel: (852) 2950 9168
Fax: (852) 2950 9303
Email: info@uni-trend.com
<http://www.uni-trend.com>